

**FMI 3-0.1**

---

---

**THE MODULAR FORCE**

---

---

**January 2008**

**DISTRIBUTION RESTRICTION:** Approved for public release; distribution is unlimited.

---

---

**Headquarters, Department of the Army**

---

---

This publication is available at  
Army Knowledge Online ([www.us.army.mil](http://www.us.army.mil)) and  
General Dennis J. Reimer Training and Doctrine  
Digital Library at ([www.train.army.mil](http://www.train.army.mil)).

# The Modular Force

## Contents

	<b>Page</b>
<b>PREFACE</b> .....	<b>v</b>
<b>INTRODUCTION</b> .....	<b>vii</b>
<b>Chapter 1 THE ARMY AND JOINT FORCES</b> .....	<b>1-1</b>
Joint Interdependence .....	1-1
Changed Concepts for Joint and Army Operations .....	1-1
Army Contributions to the Joint Force .....	1-1
Transforming to a Modular Army .....	1-2
Other Brigades and Units .....	1-20
Modular Army Forces Controlled by Other Services .....	1-21
<b>Chapter 2 MODULAR FORCE ORGANIZATION</b> .....	<b>2-1</b>
Organizing the Force .....	2-1
Understanding the Force Pool .....	2-2
Command Relationships .....	2-4
Organizing the Modular Force .....	2-4
<b>Chapter 3 THEATER ARMY ORGANIZATION</b> .....	<b>3-1</b>
Role of the Theater Army .....	3-1
The Theater Army Headquarters .....	3-3
Subordinate Commands of a Theater Army .....	3-8
Command Post Security .....	3-31
The OCP as a Joint Force Land Component Headquarters .....	3-32
The OCP as a Joint Task Force Headquarters .....	3-33
<b>Chapter 4 CORPS HEADQUARTERS ORGANIZATION</b> .....	<b>4-1</b>
Primary Roles of a Corps Headquarters .....	4-1
Modular Corps Headquarters .....	4-4
Corps Command Posts .....	4-5
United States Air Force Elements .....	4-18
United States Marine Corps Integration .....	4-18
Multinational Integration .....	4-18
Corps Headquarters Battalion .....	4-19

---

**Distribution Restriction:** Approved for public release; distribution is unlimited.

	Corps Headquarters as a JTF Headquarters .....	4-19
	Corps Headquarters as a JFLC Headquarters .....	4-20
<b>Chapter 5</b>	<b>DIVISION HEADQUARTERS ORGANIZATION.....</b>	<b>5-1</b>
	The Modular Division .....	5-1
	Division Command Posts.....	5-2
	Division Headquarters Battalion .....	5-20
	Division Headquarters as a JTF Headquarters .....	5-23
	Division Headquarters as a JFLC Headquarters .....	5-23
	<b>GLOSSARY .....</b>	<b>Glossary-1</b>
	<b>REFERENCES.....</b>	<b>References-1</b>
	<b>INDEX .....</b>	<b>Index-1</b>

## Figures

Introductory figure 1. Theater-level modular units .....	viii
Introductory figure 2. Major modular units (support brigades).....	viii
Figure 1-1. Common theater army's subordinate units .....	1-7
Figure 1-2. The theater army provides ADCON of Army forces and supports the joint force.....	1-8
Figure 1-3. The theater army's warfighting roles .....	1-9
Figure 1-4. Corps as an intermediate tactical headquarters .....	1-10
Figure 1-5. Organization of a division .....	1-11
Figure 1-6. Task-organized division for different operations .....	1-12
Figure 1-7. Heavy, infantry and Stryker brigade combat teams .....	1-13
Figure 1-8. Five types of support brigades .....	1-14
Figure 1-9. Example of additional brigades attached to a division .....	1-21
Figure 1-10. A MEB under TACON to a Marine expeditionary force.....	1-22
Figure 2-1. Organizing the force .....	2-2
Figure 2-2. The ARFORGEN model .....	2-3
Figure 2-3. Example of split ADCON relationship.....	2-6
Figure 2-4. Strategic organization of a BCT in CONUS .....	2-7
Figure 2-5. Example of force tailoring .....	2-8
Figure 2-6. Example of task organization in a division .....	2-9
Figure 3-1. The theater army supporting a joint task force.....	3-2
Figure 3-2. Theater army headquarters and main command post .....	3-5
Figure 3-3. Operational command post .....	3-6
Figure 3-4. Early entry command post.....	3-7
Figure 3-5. Operational command post headquarters battalion .....	3-8
Figure 3-6. Example of theater sustainment command .....	3-9
Figure 3-7. Signal command (theater) example of subordinate elements.....	3-12
Figure 3-8. Example military intelligence brigade .....	3-14
Figure 3-9. USAR civil affairs brigade operational structure.....	3-16

Figure 3-10. USAR civil affairs brigade functional specialty cell .....	3-17
Figure 3-11. Example medical command (deployment support) .....	3-18
Figure 3-12. Battlefield coordination detachment organization .....	3-19
Figure 3-13. Theater AAMDC and AMD brigade .....	3-21
Figure 3-14. Army field support brigade .....	3-22
Figure 3-15. Notional theater engineer command .....	3-23
Figure 3-16. Notional theater aviation command .....	3-24
Figure 3-17. Theater aviation brigade .....	3-25
Figure 3-18. Chemical force command control relationships .....	3-26
Figure 3-19. Example of theater army as a joint force land component .....	3-32
Figure 3-20. Theater army as a joint task force .....	3-34
Figure 4-1. Corps headquarters as an intermediate tactical headquarters .....	4-2
Figure 4-2. Corps headquarters as a joint task force headquarters .....	4-3
Figure 4-3. Corps headquarters as a joint force land component headquarters .....	4-4
Figure 4-4. Corps headquarters organization .....	4-5
Figure 4-5. Corps main command post organization .....	4-7
Figure 4-6. Current operations cell at the main command post .....	4-8
Figure 4-7. Personal staff sections .....	4-10
Figure 4-8. Movement and maneuver cell at the main command post .....	4-11
Figure 4-9. Intelligence cell at the main command post .....	4-13
Figure 4-10. Corps main command post fires cell .....	4-13
Figure 4-11. Sustainment cell .....	4-14
Figure 4-12. C4OPS cell in the corps main command post .....	4-15
Figure 4-13. Corps main command post protection cell .....	4-16
Figure 4-14. Tactical command post functional cells and elements .....	4-17
Figure 4-15. Corps headquarters battalion organization .....	4-19
Figure 5-1. Division command and control nodes .....	5-3
Figure 5-2. Example layout of the division main command post .....	5-5
Figure 5-3. Organizing main command post by integrating functional cells and other elements .....	5-7
Figure 5-4. Personal staff sections .....	5-8
Figure 5-5. Main command post current operations cell .....	5-9
Figure 5-6. Main command post plans cell .....	5-10
Figure 5-7. Main command post movement and maneuver cell .....	5-12
Figure 5-8. Main command post intelligence cell .....	5-13
Figure 5-9. Main command post fires cell .....	5-14
Figure 5-10. Main command post sustainment cell .....	5-14
Figure 5-11. Division main command post C4OPS cell .....	5-15
Figure 5-12. Main command post protection cell .....	5-16
Figure 5-13. Warfighting function organization of the command post .....	5-17
Figure 5-14. Division headquarters battalion organization .....	5-20

**Contents**

---

Figure 5-15. Division headquarters battalion signal operations company..... 5-22  
Figure 5-16. Division headquarters battalion support company ..... 5-22

**Tables**

Table 1-1. Projected Army units by movement and maneuver warfighting function ..... 1-2  
Table 1-1. Projected Army units by movement and maneuver warfighting function  
(continued)..... 1-3  
Table 1-2. Projected Army units by intelligence warfighting function ..... 1-3  
Table 1-3. Projected Army units by fires warfighting function..... 1-3  
Table 1-4. Projected Army units by sustainment warfighting function..... 1-3  
Table 1-5. Projected Army units by command and control warfighting function..... 1-4  
Table 1-6. Projected Army units by protection warfighting function ..... 1-4

# Preface

## PURPOSE

This publication is an updated and abridged edition of the *Army Comprehensive Guide to Modularity* released in October 2004. Since then, the modular force has evolved, and understanding of its employment has improved. This publication is not the only source of modular force information. Proponent centers and schools are developing field manuals that address employment of modular force organizations.

The most important changes to information in the *Army Comprehensive Guide to Modularity* include—

- Symbols and designations for modular force organizations are updated.
- Material on modular force employment is eliminated. (FM 3-0 addresses this subject.)
- Emerging concepts for Army force generation (ARFORGEN) and readiness are added.
- Emerging concepts for employing a corps headquarters are added.
- Revisions to the set of modular theater army-level commands and forces are added.
- Subordinate modular brigade structures are updated.
- The discussion of the brigade combat team (BCT) is reduced. (FM 3-90.6 addresses BCT operations.)
- The Army's operational concept, full spectrum operations, is incorporated.
- Modular force sustainment concepts are updated.
- The most up-to-date summation of the organization of the theater army, corps, division, and BCT echelons—including changes scheduled for force design updates—is included.

This publication describes why and how the Army is changing its warfighting doctrine, organizations, training, and operations. It summarizes the reasons for changes and describes the principles underlying Army transformation. It also explains how those principles shape ongoing change and describes projected changes for the Army in the next two decades.

## SCOPE

This publication is organized into five chapters:

- Chapter 1 summarizes the relationship of the Army to the joint force and modular Army forces.
- Chapter 2 describes modular force organization including ARFORGEN, tailoring, and task-organizing.
- Chapter 3 describes the theater army headquarters organization.
- Chapter 4 describes the corps headquarters organization.
- Chapter 5 describes the division headquarters organization.

Not all the units of the Army are scheduled to be organized as modular brigades. Existing doctrine for functional brigades still applies. This publication does not supersede existing Army operational and tactical doctrine. Rather, it offers modifications to the basic concepts contained within FM 3-0, FM 3-90, and FM 3-07.

## APPLICABILITY

This publication applies to the Active Army, Army National Guard/Army National Guard of the United States, and U.S. Army Reserve unless otherwise stated. It forms the foundation for modular force curriculum within the Army Education System.

## ADMINISTRATIVE INFORMATION

Most terms with joint or Army definitions are identified in both the glossary and the text. *Glossary references*: Terms for which FMI 3-0.1 is the proponent publication (the authority) are indicated with an asterisk in the glossary. *Text references*: Definitions for which FMI 3-0.1 is the proponent publication are printed in boldface in the text. These terms and their definitions will be incorporated into the next revision of FM 1-02. For other definitions in the text, the term is italicized and the number of the proponent publication follows the definition.

Headquarters, U.S. Army Training and Doctrine Command is the proponent for this publication. The preparing agency is the Combined Arms Doctrine Directorate, U.S. Army Combined Arms Center. Send written comments and recommendations on a DA Form 2028 (Recommended Changes to Publications and Blank Forms) to Commander, U.S. Army Combined Arms Center and Fort Leavenworth, ATTN: ATZL-CD (FMI 3-0.1), 201 Reynolds Avenue, Fort Leavenworth, KS 66027-2337; by e-mail to website [leav-cadd-web-cadd@conus.army.mil](mailto:leav-cadd-web-cadd@conus.army.mil); or submit an electronic DA Form 2028.

Since *ARFOR* is a defined term as well as an acronym, it is not spelled out.



# Introduction

## WHY THE ARMY IS TRANSFORMING

The Army is at war. Since Operation Desert Storm in 1991 it has been committed to a series of operations that have intensified since the homeland was attacked on 11 September 2001.

Since that attack, Army and joint forces have deployed repeatedly for conventional and irregular warfare, and on missions as different as noncombatant evacuation, peacekeeping, and homeland security. Wartime missions and circumstances have forced the Army to adapt to enemies and conditions pragmatically, changing old arrangements decisively and quickly. Even if worldwide contingencies were not forcing the pace of action, the Army and the joint force would still face change. Strategic adjustments after the Cold War—new opponents, new liabilities, new opportunities—and the need to accommodate constant technological developments would have required the armed forces to change to remain effective. In less than a decade, the U.S. military has evolved dramatically under the pressure of these changes. This evolution has transformed operations from loosely linked, Service-dominated operations into fully integrated, interdependent campaigns.

In the past, operations were broadly classified as continental, maritime, aerospace, or unconventional. Today's joint operations are unified actions employing all instruments of national power throughout a complex, interconnected, and increasingly global operational environment encompassing the air, land, maritime, and space domains, and the information environment. Formerly the land, air, and sea Services each dominated a distinct type of warfare. Today a combatant commander can bring every Service component's capabilities to bear anywhere in its area of responsibility. The influence of other government agencies on campaigns is greater now than in the past. Army leaders now act in a fully integrated and interdependent joint environment. The actions of other Service components complement and reinforce the actions of land force leaders. Accustomed to being supported commanders in fairly restricted areas of operations (AOs), land force commanders now find themselves supporting and being supported by air, maritime, space, and special operations components in distinctly different operations. Increasingly, this integration of joint operations also occurs at the tactical level, increasing the effectiveness of battalions and brigades. Getting the full benefit of this combat power has been a major consideration in revising Army operations and organizations.

## THE SOLUTION—MODULAR ORGANIZATIONS

Army transformation focuses on providing flexible and responsive capabilities to joint force commanders. Flexibility is vital to implementing new warfighting doctrine and to responding to the wide range of operational challenges. Responsiveness is characterized by three attributes:

- Army forces are modular, allowing for a selective mix of units that meets the needs of combatant commanders at any time and place.
- Army forces deploy more capable forces directly into the joint operations area when a campaign begins. This allows joint force commanders to exercise the full, complementary range of joint capabilities and confront enemies with a nearly insoluble dilemma.
- The higher echelon command structure provides combatant commanders with a scalable battle command capability that facilitates command and control across the operational area with greater effectiveness and efficiency.

Modular organizations facilitate meeting the challenges of the 21st century operations. The BCT is now the largest fixed tactical combined arms organization. Three types of BCTs exist: heavy, infantry, and Stryker. In addition, specialized brigades may be assigned to any division, corps, or theater army headquarters as

the situation requires. FMI 3-0.1 discusses these new organizations, how they contribute to the joint force, and how they conduct operations.

## **MODULAR SYMBOLS AND UNITS**

The introductory figures illustrate unit symbols and designations currently used or planned for modular forces.

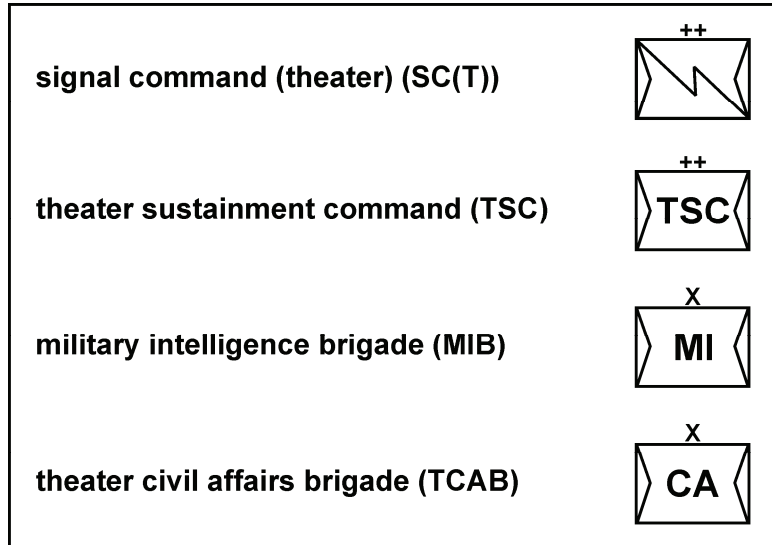

**Introductory figure 1. Theater-level modular units**

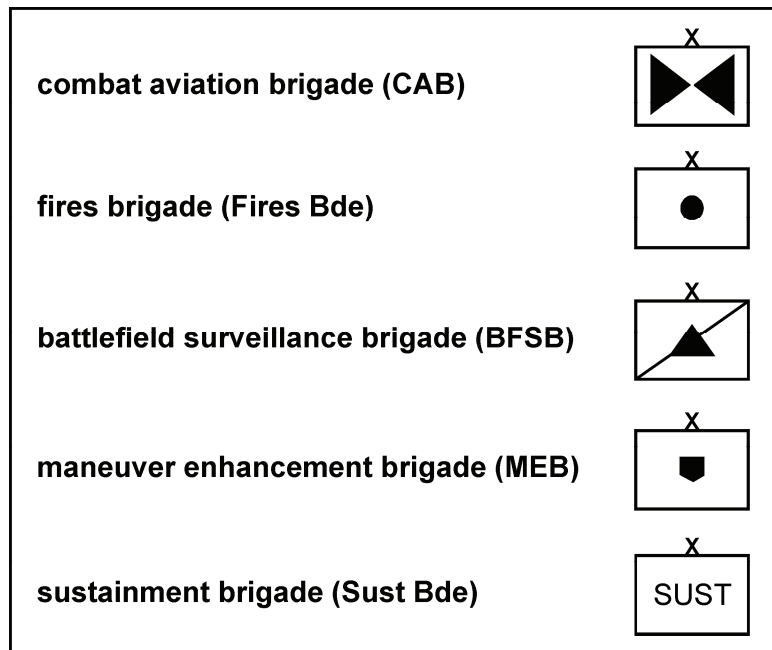

**Introductory figure 2. Major modular units (support brigades)**

## Chapter 1

# The Army and Joint Forces

This chapter describes the two types of forces: Army and joint. It discusses the changes in concepts and contributions to each for force. It discusses how the transformation to a modular Army affects higher echelons, brigades and Army forces controlled by other Services.

### **JOINT INTERDEPENDENCE**

1-1. Joint interdependence allows each Service to divest itself of redundant functions that another Service provides better. Doing this reduces unnecessary duplication of capabilities among the Services. It achieves greater efficiency in all areas of expertise. Interdependence allows the Army to focus on developing capabilities that only land forces can provide. Likewise, relying on the Army for land-related capabilities allows the other Services to achieve greater efficiencies in their respective domains. (JP 3-0 and FM 1 describe joint interdependence.)

### **CHANGED CONCEPTS FOR JOINT AND ARMY OPERATIONS**

1-2. Today, U.S. strategic planning addresses four challenges:

- Catastrophic challenges involving the acquisition, possession, and use of weapons of mass destruction.
- Irregular challenges from enemies employing unconventional methods to counter the traditional advantages of stronger opponents.
- Disruptive challenges from adversaries and enemies who develop and use breakthrough technologies to negate current U.S. advantages in key operational domains.
- Traditional challenges posed by states employing recognized military capabilities and forces in understood forms of military competition and conflict.

These challenges are not mutually exclusive. Current enemies and adversaries may use some or all of them against United States.

1-3. Joint forces—including the Army—respond to these four strategic challenges with changes in doctrine, training, leader development, organization, and materiel. The Army's operational concept—full spectrum operations—forms the core of the Army's warfighting doctrine. (FM 3-0 discusses the operational concept and the fundamentals that support it.)

### **ARMY CONTRIBUTIONS TO THE JOINT FORCE**

1-4. Cold War forces depended on multiple echelons of highly specialized combat support and combat service support structures. While their numbers and capabilities were reinforced as alert stages rose, they were not expected to deploy outside of their assigned theaters. Indeed little of this forward deployed support structure was expected to move from its initial locations within a theater of operations. Within the North Atlantic Treaty Organization, each nation provided its own intelligence, supplies, and services to its own formations. Allies shared intelligence and logistics to some extent, but this was constrained significantly by security concerns and interoperability limitations. Cooperative, well-prepared host-nation auxiliary forces had the mission of meeting many of the force's engineer, signal augmentation, and sustainment needs.

1-5. The Army has to adopt an expeditionary mindset and the capability to deploy anywhere, anytime, and anyhow. Such expeditionary warfare calls for different support structures than were appropriate during the Cold War. Joint forces that deploy rapidly into unprepared theaters with little or no advance warning need the capability to deploy and employ assets representing all six warfighting functions simultaneously. To speed deployment, joint force commanders want the smallest, most flexible structures possible. The Army, which is charged with functional responsibilities to the other Service components and the theater, has had a particular interest in redesigning components of the theater army.

1-6. Army forces provide specialized capabilities to protect the joint force. These include air and missile defense forces; chemical, biological, radiological, and nuclear defense elements; explosive ordnance disposal; counterintelligence; and military police.

1-7. During the Cold War, every fighting echelon from the Army group to the maneuver battalion and separate company had its own sustainment organization. This support structure exceeded World War II and Korean War levels. Faced with a numerically superior opponent and potentially high consumption rates, large casualty rates, and massive equipment replacement needs, the Army's leadership believed these large support echelons were necessary.

1-8. Developments in communications, automated inventory management, and all modes of transportation now offer opportunities to compress and accelerate Army and joint sustainment operations. Joint and Army logisticians have since revised their concepts. Better forecasting and reporting of requirements, improved transportation and materiel handling, asset visibility, and an enhanced sharing of information and materiel among Service components, civilian agencies, and allies all play a part in this. The result of sustainment transformation will be a vertically and horizontally integrated joint system. This system will enable sustainers to deliver better service to all joint, interagency, and multinational customers throughout a theater of operations. During future contingency operations, joint and Army sustainers will anticipate requirements based on more accurate reporting and predictions. They will "see" and "manage" supplies in transit while changing destinations and supply routes based on current operational and tactical requirements.

## TRANSFORMING TO A MODULAR ARMY

1-9. The relationship between the Army and the other Services has changed over the last twenty years from joint deconfliction, through joint synchronization, to joint interdependence. Now the Army is redesigning its combat and support units into modular organization. Then Army forces will better meet current and projected future operational requirements that reflect this joint interdependence. By 2011, the new modular organizations will provide a mix of land combat power that can be task-organized for any combination of offensive, defensive, and stability or civil support operations as part of a campaign. Tables 1-1 to 1-6 (pages 1-2–1-4) show the end state resourcing in fiscal year 2011 by warfighting function based on the Army Campaign Plan, Change 5. As part of this redesign, the Army has largely converted its basic ground combat force from divisions to brigade combat teams. This redesign effort with its associated rebalancing, stabilization, and cyclical readiness initiatives all reflect the Army's transformation to a modular Army.

**Table 1-1. Projected Army units by movement and maneuver warfighting function**

	Regu- lar Army	ARN G	USA R
<b>Brigade Combat Teams/Armored Cavalry Regiment (Total)</b>	<b>48</b>	<b>28</b>	<b>–</b>
Heavy brigade combat team	18	7	–
Armored cavalry regiment	1	–	–
Stryker brigade combat team	6	1	–
Infantry brigade combat team	23	20	–

**Table 1-1. Projected Army units by movement and maneuver warfighting function (continued)**

	Regu- lar Army	ARN G	USA R
<b>Combat Aviation Brigades (Total)</b>	<b>11</b>	<b>8</b>	<b>–</b>
Combat aviation brigade (heavy)	5	2	–
Combat aviation brigade (medium)	4	–	–
Combat aviation brigade (light)	2	–	–
Combat aviation brigade (expeditionary)	–	6	–
Special forces group (airborne)	5	2	–
Ranger regiment	1	–	–
Special operations aviation regiment	1	–	–

**Table 1-2. Projected Army units by intelligence warfighting function**

	Regu- lar Army	ARN G	USA R
Military intelligence brigade	10	–	–
Battlefield surveillance brigade	4	6	–

**Table 1-3. Projected Army units by fires warfighting function**

	Regu- lar Army	ARN G	USA R
Electronic warfare group	2	–	–
Fires brigade	6	7	–
Information operations group	–	2	2
Psychological operations group	1	–	2

**Table 1-4. Projected Army units by sustainment warfighting function**

	Regu- lar Army	ARN G	USA R
Army field support brigade	7	1	3
Financial management center	3	–	4
Human resources sustainment center	3	–	2
Medical brigade	4	–	10
Medical deployment sustainment command	2	–	2
Ordnance group	2	1	–
Quartermaster group	1	–	3
Regional support groups	–	17	25

**Table 1-4. Projected Army units by sustainment warfighting function**

	Regu- lar Army	ARN G	USA R
Sustainment brigade	14	9	9
Sustainment brigade (special operations)	1	–	–
Theater airfield operations group	1	1	–
Theater aviation supply and maintenance group	–	4	–

**Table 1-5. Projected Army units by command and control warfighting function**

	Regu- lar Army	ARN G	USA R
<b>Army Service Component Commands (Total)</b>	<b>9</b>	–	–
Theater army headquarters	6	–	–
Functional Army Service component command	3	–	–
Nonmodular Army headquarters	1	–	–
<b>Theater Subordinate Commands</b>	<b>8</b>	<b>6</b>	<b>16</b>
Air and missile defense command	2	1	–
Aviation command	–	1	1
Chemical, biological, radiological, nuclear, and high-yield explosives (CBRNE) command	1	–	–
Civil affairs command	–	–	4
Engineer command	–	–	2
Military police command	–	1	1
Signal command	–	–	2
Expeditionary sustainment command	4	2	7
Sustainment command	3	1	1
Corps headquarters	3	–	–
Division headquarters	10	8	–
Information operations command	1	–	–
Signal brigade	9	2	1
Space brigade	1	–	–
Theater aviation brigade	1	5	1

**Table 1-6. Projected Army units by protection warfighting function**

	Regu- lar Army	ARN G	USA R
Air defense artillery brigade	4	2	–
Ground-based midcourse defense brigade	–	1	–
Maneuver enhancement brigade (MEB)	4	16	3
Engineer brigade	5	7	4
Military police brigade	6	3	3
Criminal investigation detachment	2	–	–

**Table 1-6. Projected Army units by protection warfighting function**

	Regu- lar Army	ARN G	USA R
Chemical brigade	1	1	1
ARNG Army National Guard USAR United States Army Reserve			

1-10. Throughout the 20th century, the Army’s largest tactical fixed-organization was the division echelon. In both the Reorganization of Army Division (known as ROAD) and the Army of Excellence (AOE) constructs, a division consisted of three maneuver brigades, an artillery brigade, and a division base of specialty troops. Heavy AOE divisions included an engineer brigade in addition to an aviation brigade. Division strength numbered from 10,000 to 16,000 Soldiers and employed all the Army’s fighting systems. Divisions fought battles to gain tactical advantage under the command of a corps headquarters. Close coordination and direct support of brigade operations characterized the division’s tactical activities. Brigades operated near to each other and typically depended on their neighbors’ success or reinforcement and on combat and logistic support from the division.

1-11. Divisional brigades consisted of three or four maneuver battalions. These battalions were cross-attached to form combined arms tasks forces. They received artillery, engineers, communications and other support from division-level units. While Cold War doctrine stressed flexibility in brigade organization, the tendency to develop habitual relationships between combat brigades and their supporting units led to the development of de facto fixed organizations similar in principle to the new brigade combat teams (BCTs).

**HIGHER ECHELONS**

1-12. Between now and 2010, the Army will replace AOE higher headquarters designs (largely focused on tactical warfighting) with headquarters designed to provide command and control for full spectrum operations. The latter headquarters applies to the tactical and operational levels without additional Army augmentation. Currently, these headquarters are designated divisions, corps, and theater armies. While the tendency is to think of these echelons as linear improvements to their predecessors, they are not. All three echelons are complementary, modular entities designed to employ task-organized forces in integrated campaigns.

1-13. The Army, as part of transformation, has redesignated its structure outside of the Department of the Army Headquarters staff into three types of organizations: Army commands, Army Service component commands (ASCCs), and direct reporting units (DRUs). Three Army Commands exist—U.S. Army Forces Command (FORSCOM), U.S. Army Training and Doctrine Command (known as TRADOC), and U.S. Army Materiel Command (known as AMC). Each unified command has an associated ASCC. These are—

- United States Army, Central Command (USARCENT)/3rd Army for United States Central Command (USCENTCOM).
- United States Army, European Command (USAREUR)/7th Army for United States European Command (USEUCOM).
- United States Army Forces Command for United States Joint Forces Command (USJFCOM). (FORSCOM is both an Army command and an ASCC.)
- United States Army, Northern Command (USARNORTH)/5th Army for United States Northern Command (USNORTHCOM).
- United States Army, Pacific Command (USARPAC) for United States Pacific Command (USPACOM).
- United States Army, Southern Command (USARSO)/6th Army for United States Southern Command (USSOUTHCOM).
- United States Army Space and Missile Defense Command/ United States Army Forces Strategic Command for United States Strategic Command (USSTRATCOM).

- United States Army Special Operations Command (USASOC) for United States Special Operations Command (USSOCOM).
- Military Surface Deployment and Distribution Command for United States Transportation Command (USTRANSCOM).
- Eighth U.S. Army (EUSA) for the United States Forces, Korea (USFK) subunified command.

An ASCC that supports a geographic combatant commander (GCC) is also known as a theater army headquarters. FM 3-0 discusses the combatant commands and ASCCs.

1-14. The Army's eleven DRU's are—

- United States Army Acquisition Support Center.
- United States Army Corps of Engineers.
- United States Army Criminal Investigation Command.
- United States Army Installation Management Command.
- United States Army Intelligence and Security Command.
- United States Army Medical Command.
- United States Army Military Academy.
- United States Army Military District of Washington.
- United States Army Network Enterprise Technology Command (NETCOM)/9th Signal Command (Army).
- United States Army Reserve (USAR) Command.
- United States Army Testing and Evaluation Command.

### Theater Army Headquarters

1-15. Each theater army headquarters is composed of three different units. (See figure 1-1.) These are the main command post (CP) with a headquarters and headquarters company, the operational command post (OCP), and a headquarters battalion. The main CP consolidates most administrative functions into a command post previously performed by AOE corps and ASCC headquarters. As the primary vehicle for Army support to a GCC's area of responsibility, the main CP supports deployed Army, joint, and multinational forces. The theater army commander performs as the ASCC commander for the geographic combatant command. In major combat operations, where the GCC is the joint force commander (JFC), the theater army commander may become the joint force land component commander. When required, the OCP provides a joint task force (JTF)-capable headquarters without initial additional Army augmentation to control forces in a joint operations area (JOA).



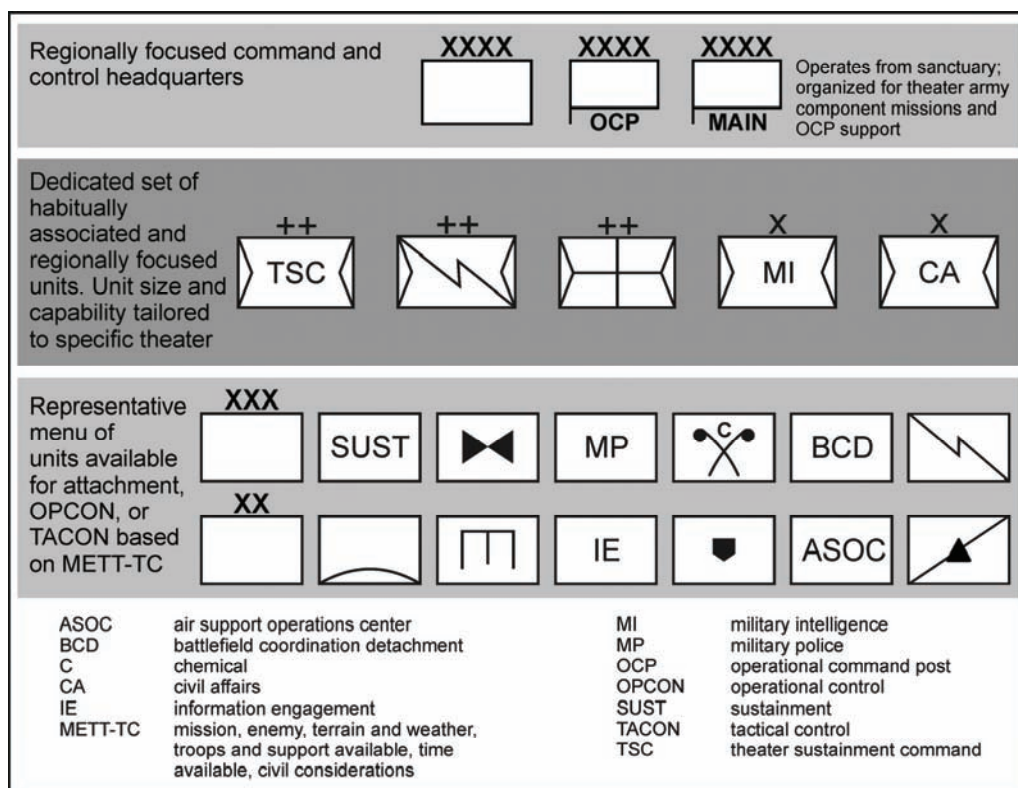

**Figure 1-1. Common theater army's subordinate units**

1-16. Three broad design concepts underlie the theater army organization:

- First, the theater army main CP is regionally focused. It is not a “pooled” headquarters. It remains the senior Army headquarters for the theater and does not deploy to another theater.
- Second, the theater army provides administrative control (ADCON) over all Army forces assigned or attached to the GCC and controls Army support to joint, interagency, and multinational elements as directed by the GCC. The theater army performs the latter continuous task regardless of whether it also controls land forces in a major operation.
- Third, the theater army provides a command and control capability to conduct major operations. As operations continue, the GCC, JTF, or Army commander may need to augment the main CP and OCP based on the factors of METT-TC. The theater army design provides its commander with sufficient command and control capabilities for the initial phase of any campaign, while providing a flexible platform for Army and joint augmentation.

1-17. Each theater army will be assigned or attached a mix of forces to support the theater. While the type and size of forces will vary, the theater army normally has a theater sustainment command, a signal command (theater), a medical deployment support command, a military intelligence brigade, and a civil affairs unit (command or brigade). The size of these subordinate elements depends on theater requirements. Figure 1-1 illustrates a typical theater army. It consists of a functional headquarters, an array of regionally focused theater units, and a mix of attached, operational control (OPCON), or tactical control (TACON) forces as required by ongoing operations.

1-18. The theater army commander uses the main CP to integrate Army forces into the execution of regional security cooperation plans. As directed by the GCC, the theater army commander provides Army support to joint, interagency, and multinational forces. (See figure 1-2.)

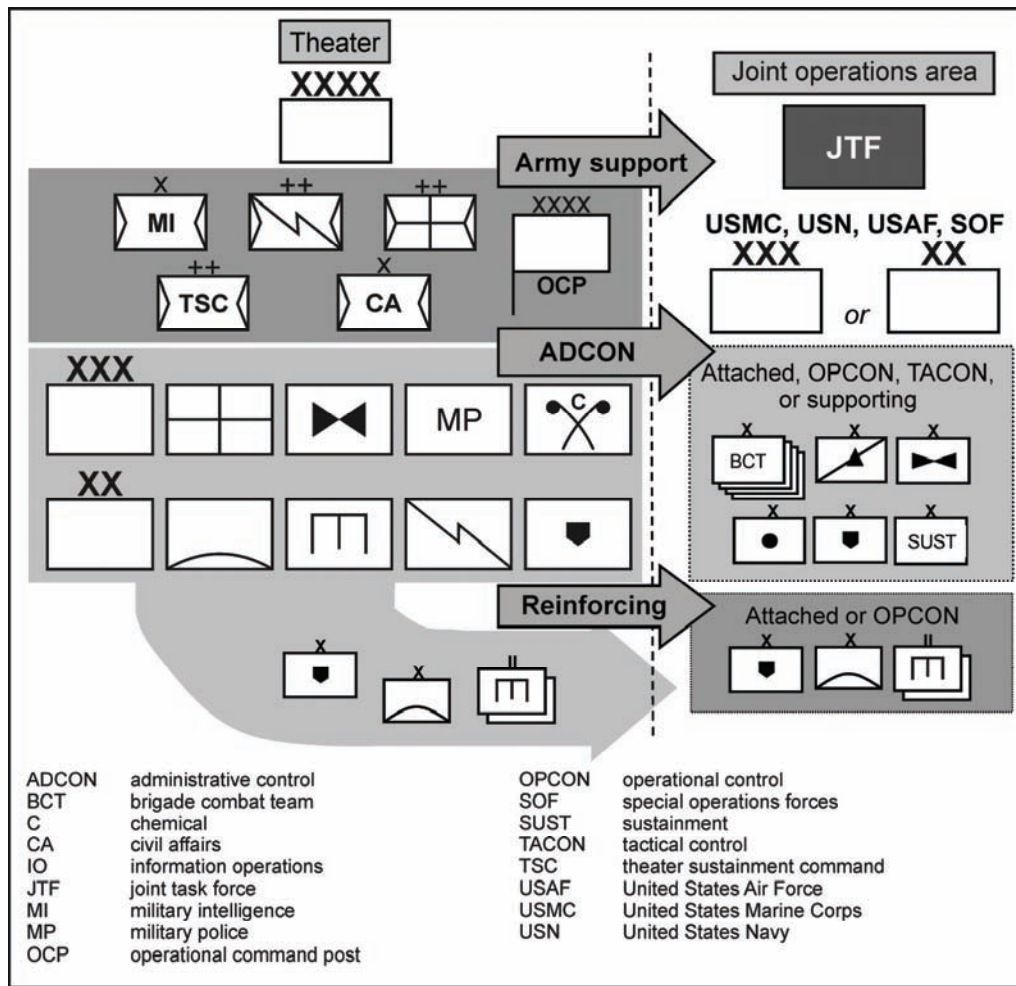

**Figure 1-2. The theater army provides ADCON of Army forces and supports the joint force**

1-19. For major combat operations, the theater army OCP may provide the base for a joint force land component (JFLC) headquarters. Simultaneously, as shown in figure 1-3, the theater army main CP continues to perform its ADCON functions.

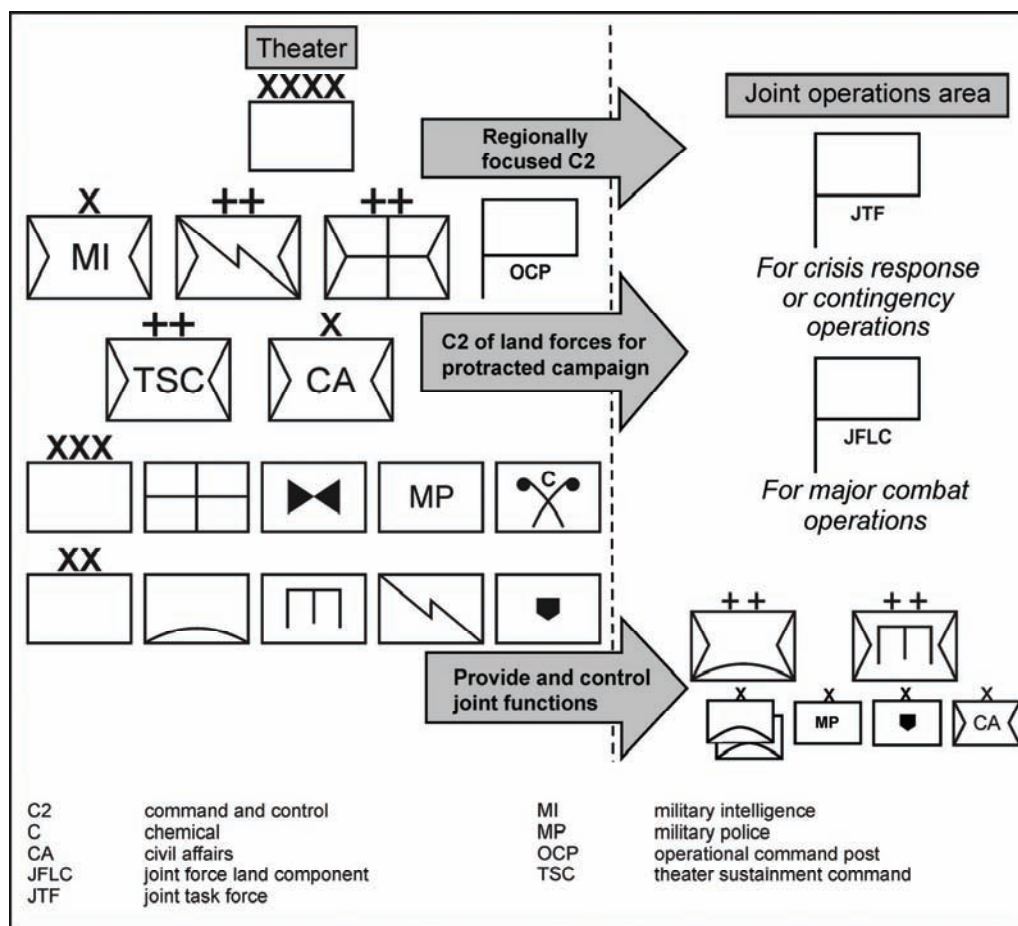

Figure 1-3. The theater army's warfighting roles

## Corps

1-20. A corps headquarters primarily serves as an intermediate-level tactical headquarters. It can also serve as an ARFOR headquarters and as base on which a joint force commander, such as a GCC, can build a JTF or JFLC headquarters. Both latter missions require the corps commander to provide operational-level command and control as well as to integrate and synchronize joint, interagency, and multinational actions in a JOA. The modular corps headquarters has no training and readiness responsibilities for other Army units in garrison. This headquarters typically focuses its training efforts on being an intermediate-level tactical headquarters unless assigned a mission that requires it to focus on joint responsibilities. However the commander has the option of shifting the training focus of the corps headquarters.

1-21. A corps headquarters requires joint augmentation to transition to a joint force headquarters. The headquarters may incorporate joint Service officers through manpower exchange programs. However, it still requires augmentation to transition into a fully functioning joint force headquarters. That augmentation may be in the form of a deployable joint cell to provide initial assistance or a major augmentation of personnel and equipment based on a joint manning document. The establishing authority provides required joint augmentation to the corps headquarters. However, the corps commander must make these augmentation requirements known to the establishing commander.

1-22. Serving as an intermediate-level tactical headquarters during the conduct of major combat operations is the primary peacetime training focus for a corps headquarters until it is given another mission. When

performing this mission, the headquarters requests and tailors its available division headquarters and modular brigades for land operations to support the JFC. It assigns a command or support relationship between its available BCTs and supporting brigades and available division headquarters. The corps commander may choose to retain direct control of selected brigade-sized elements. Conduct of battles and engagements is a tactical function exercised through BCT and supporting brigade headquarters and monitored by the available division headquarters. The corps headquarters, as an intermediate tactical headquarters, focuses on shaping the future battlefield and setting conditions that allow the success of subordinate tactical units. This capability relieves the joint force land component commander or GCC from planning and synchronizing multiple land operations conducted by large formations (two or more divisions). Figure 1-4 illustrates the use of a corps headquarters as an intermediate tactical headquarters.

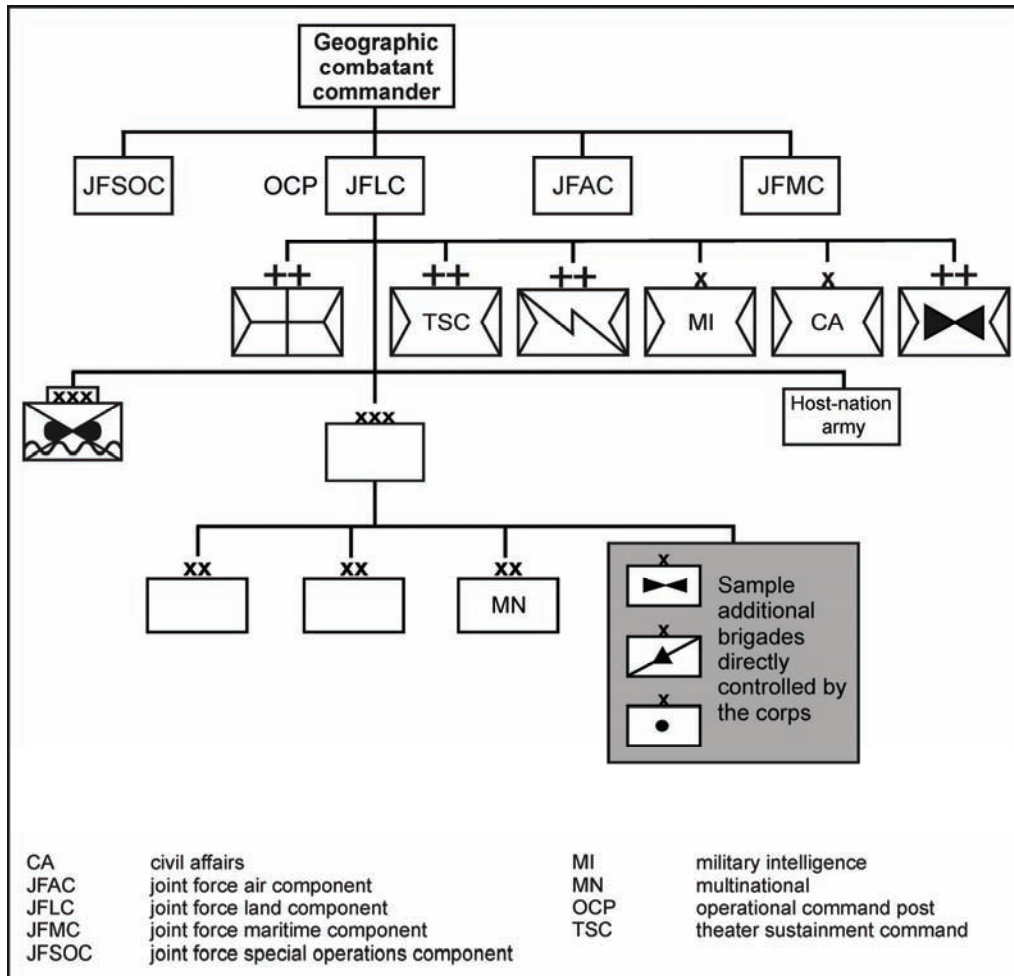

Figure 1-4. Corps as an intermediate tactical headquarters

### Division

1-23. The primary tactical warfighting modular headquarters is the division. The modular division headquarters combines the tactical functions of the AOE division and corps headquarters. The division headquarters primarily directs the operations of its subordinate BCTs and supporting brigades. It contains the resources needed to be a JTF, JFLC, or ARFOR headquarters for small-scale operations without additional Army augmentation. It does require joint augmentation to act as a JTF or JFLC headquarters. However, it

cannot simultaneously perform the functions of a JTF, JFLC, and ARFOR headquarters without significant additional Army augmentation.

1-24. The division headquarters itself is a self-contained organization. It consists of the division command group, a main CP, a tactical command post, a mobile command group, and a supporting division headquarters battalion with the signal and sustainment necessary for the division headquarters to function. The division is not a fixed formation. It is a completely modular entity exercising command and control over several brigades. The division commands a tailored mix of forces determined by the GCC based on the mission and designated by the theater army for tactical land operations. The division does not have organic forces beyond the elements that make up its headquarters. (See figure 1-5.)

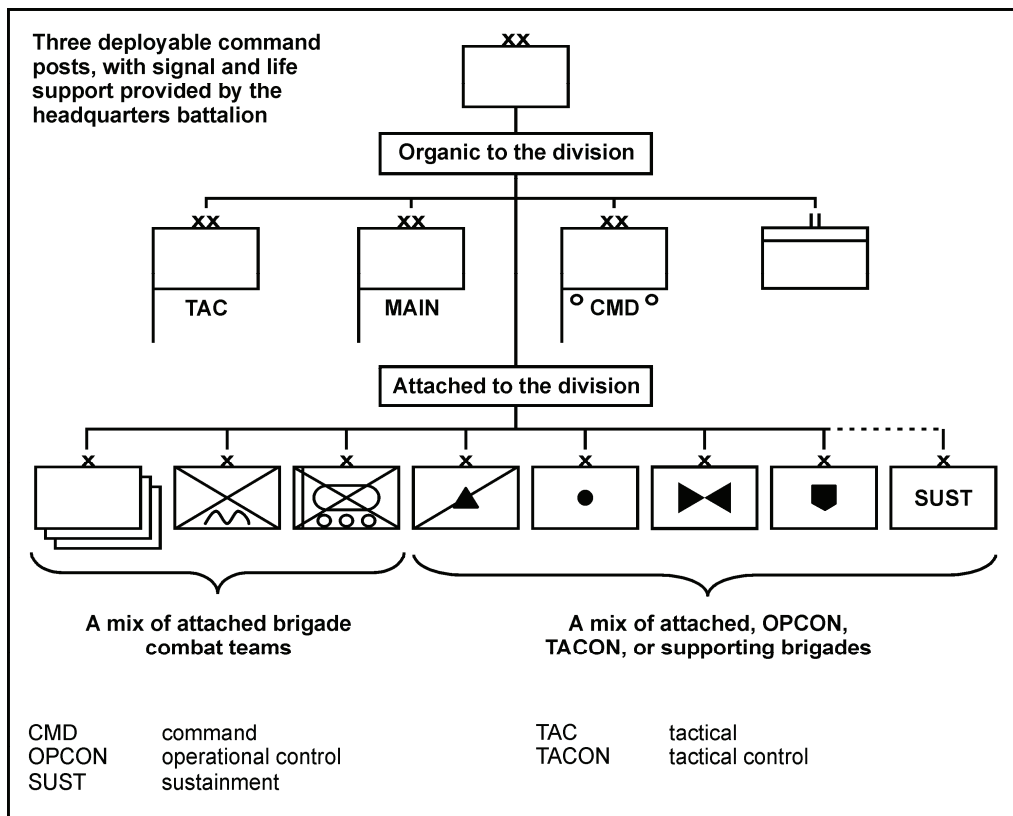
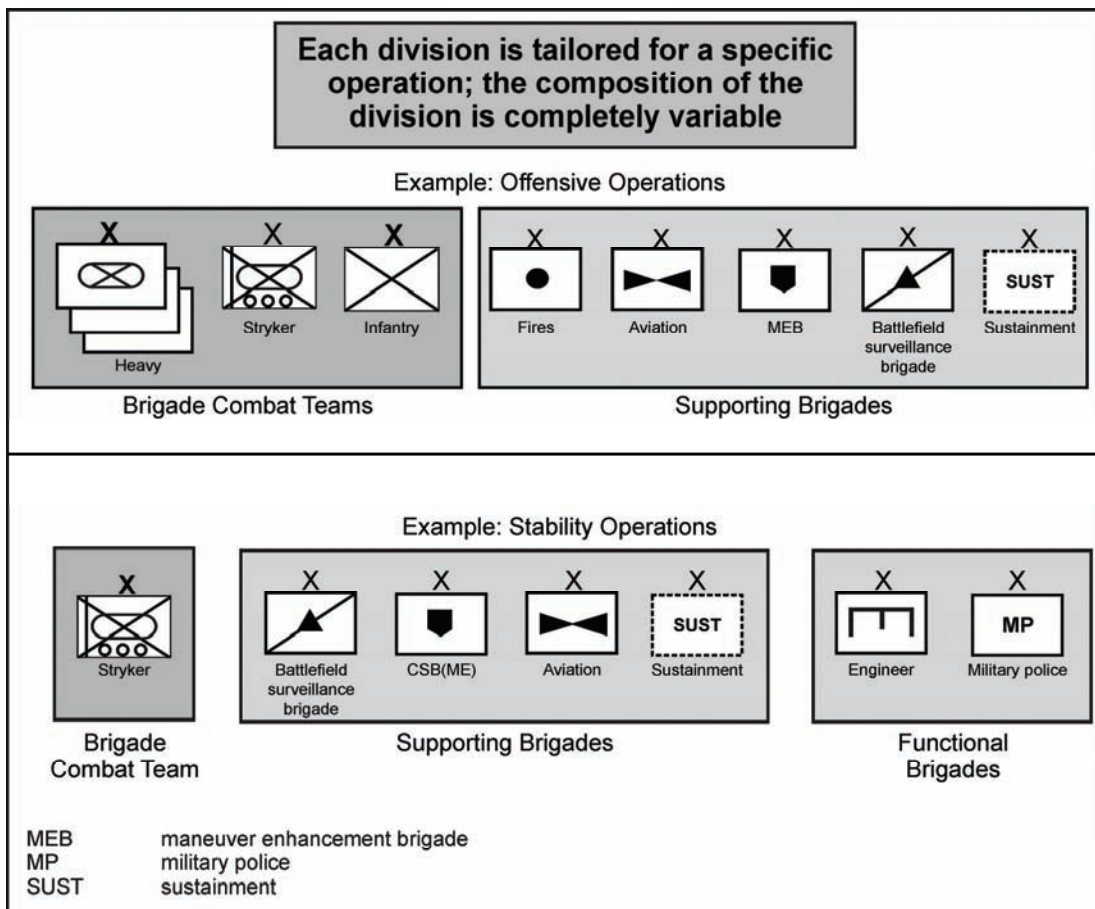

Figure 1-5. Organization of a division

1-25. In major combat operations, divisions often operate along a line of operations or in an AO. A division can control up to six BCTs with additional appropriate supporting brigades during major combat operations. The division may include any mix of heavy, infantry, or Stryker BCTs. A division requires at least one of each of the five types of support brigades to have a complete combined arms team during the conduct of major combat operations. The types of support brigades are combat aviation, fires, combat support (maneuver enhancement), battlefield surveillance, and sustainment. The sustainment brigade normally remains attached to the theater sustainment command but supports the division. The division may have OPCON of a sustainment brigade while conducting large-scale exploitation and pursuit operations. During protracted stability or civil support operations, the number of BCTs and supporting brigades controlled by a division headquarters may exceed these numbers. The division may not be supported by all five types of support brigades during later protracted types of operations since the division may not need their capabilities for ongoing operations.

1-26. The division has no fixed structure. Hence, it may not have all types of BCTs in an operation or it may control more than one of a particular type of BCT. The division may control branch-pure battalions

and separate companies, but these will be task-organized to a brigade. When the division has more than one functional battalion assigned, a functional brigade headquarters may be assigned, too. Figure 1-6 illustrates two possible division organizations. Many more combinations exist. The sustainment brigade in figures 1-5 and 1-6 has a support relationship with the division instead of a command relationship. It is attached to the theater sustainment command.



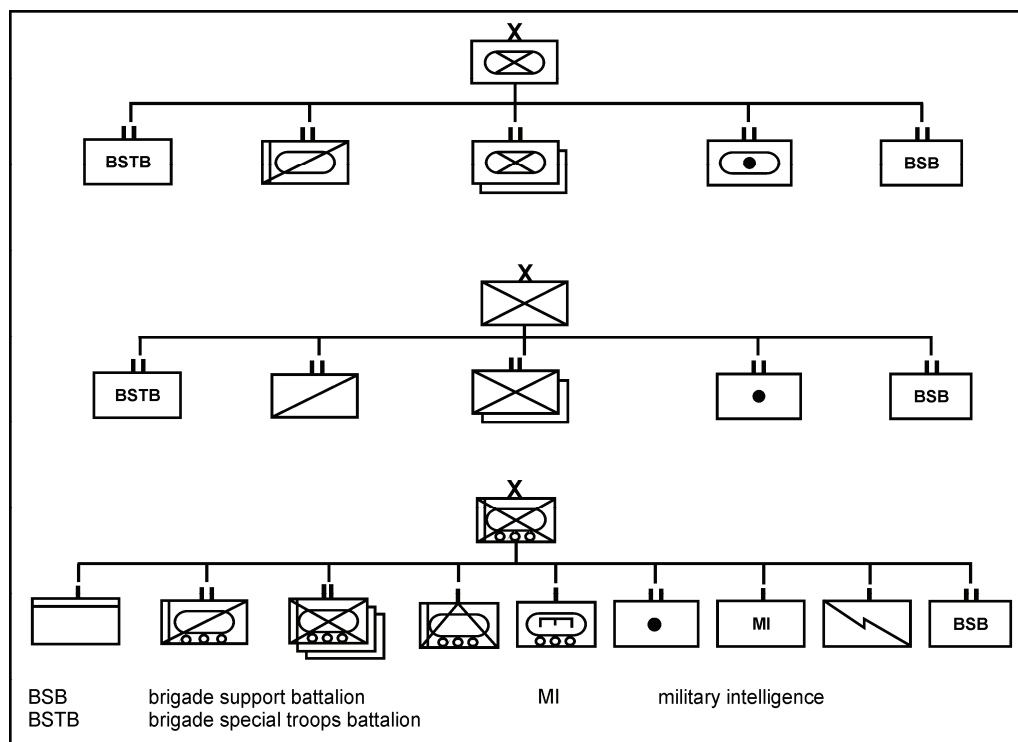

**Figure 1-7. Heavy, infantry and Stryker brigade combat teams**

1-30. Six warfighting functions exist: movement and maneuver, intelligence, fires, sustainment, command and control (C2), and protection. Units perform all these functions in a BCT. Each BCT is organized with combined arms units down to the battalion level. A C2 system that includes networked information systems, combined with advanced sensors and better analysis and information management, allows BCT commanders to see, understand, and share tactical information rapidly. Longer-range precision weapons and sensors, both organic to the BCT and from outside sources, permit the BCT commander to initiate some engagements even before ground combat arms units make contact. Leaders in the modular BCT can develop the situation, select an appropriate course of action, and communicate that course of action more effectively and with reduced risk to their Soldiers than their AOE predecessors. This is because of the BCT's greater capability to conduct reconnaissance, access to advanced information systems and decision aids that supports its C2 process, and a higher leader-to-led ratio when compared with AOE brigades. An array of more precise and lethal joint and Army supporting fires allows the BCT to win rapidly in close combat once it is initiated.

1-31. A division commander assigns tasks to BCT commanders along with a broad concept of operations. Simultaneously this commander provides the commander's intent for orientation. The division commander also designates an AO or line of operations for each BCT. As in all land operations, the division order gives BCT commanders the greatest possible tactical latitude and freedom of action. The division commander also assigns any additional capabilities to the BCTs from their available supporting brigades to task-organize them for their specific mission.

### Supporting Brigades

1-32. A mix of other brigade types supports theater army, corps, and division commanders. These supporting brigade types include the battlefield surveillance brigade (BFSB), fires brigade, combat aviation brigade (CAB), maneuver enhancement brigade (MEB), and sustainment brigade. These brigades are combined arms units designed to support BCTs and carry out specific tasks in support of echelons above BCT.

(See figure 1-8.) All five types of support brigades should support a division involved in major combat operations.

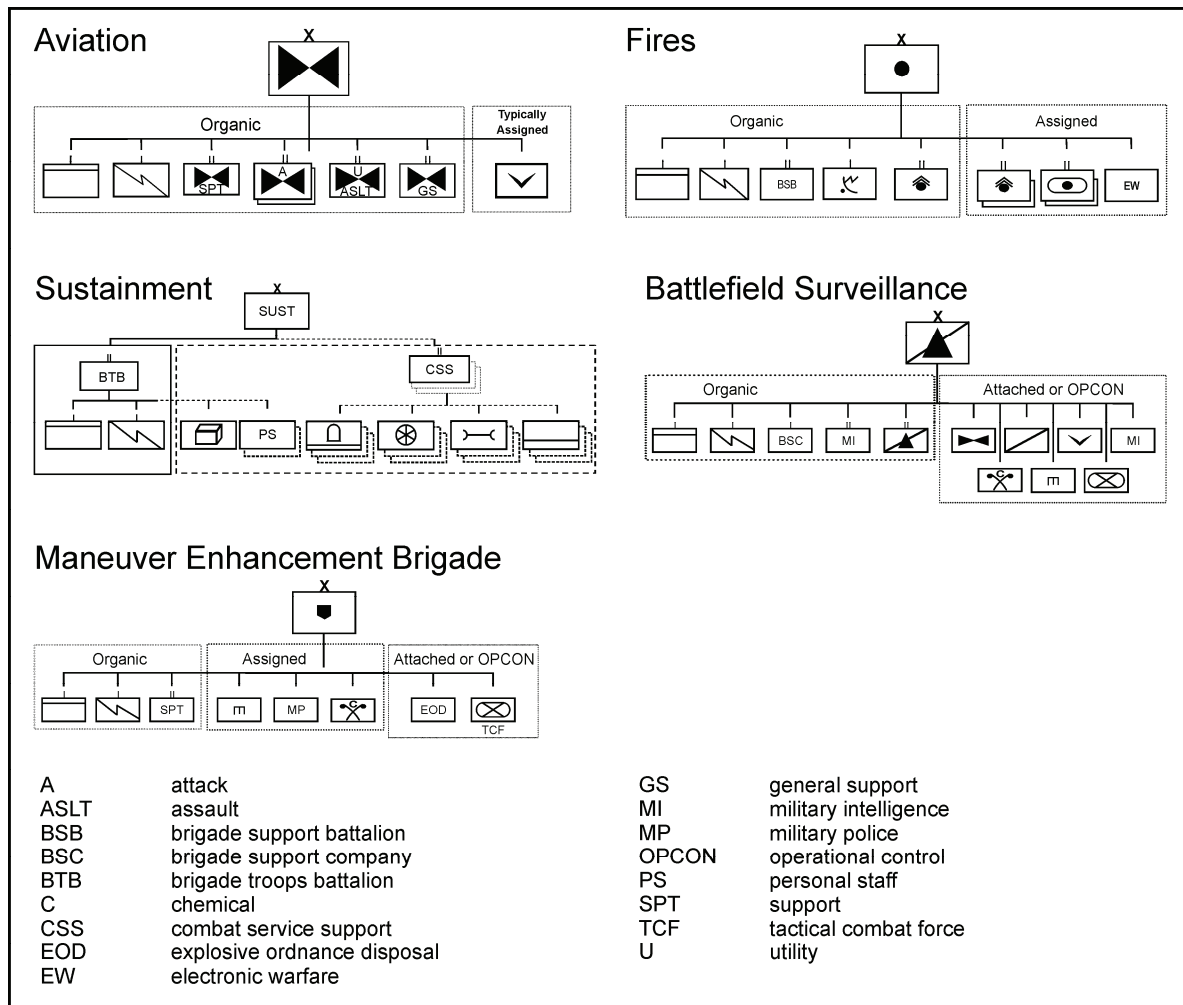

**Figure 1-8. Five types of support brigades**

1-33. Most support brigades have flexible organizations. All support brigades except the CAB are designed around a base of organic elements, to which they add a mix of additional capabilities based on the factors of METT-TC. The brigade headquarters includes the necessary expertise to control different capabilities. Each support brigade's base includes organic signal and sustainment capabilities.

***Battlefield Surveillance Brigade***

1-34. The BFSB primarily conducts intelligence, surveillance, and reconnaissance (ISR). The ARFOR commander may assign it to support a division, corps, JTF, other Service, or a multinational force. The information it collects focuses on the enemy, terrain and weather, and civil consideration aspects of the factors of METT-TC to feed the common operational picture. BFSB collection efforts focus on unassigned areas in a division's AO. Sometimes the supported commander assigns the BFSB an AO. The BFSB receives its taskings through mission orders. The supported commander describes the operation, identifies priority intelligence requirements (PIRs), and gives the BFSB a reconnaissance objective. The BFSB commander, not the supported headquarters staff, controls all assets whose primary role is collecting information in the



supported headquarters controlled areas. The BFSB commander does not control BCT ISR collection assets. Each BCT retains control of its organic collection assets and collects information in its assigned AO.

1-35. The BFSB is organized with an organic military intelligence battalion, a reconnaissance and surveillance squadron, brigade support company, and a network support company. The military intelligence battalion provides a military intelligence collection capability that includes unmanned aircraft systems (UASs), signals intelligence, human intelligence, and counterintelligence. The reconnaissance and surveillance squadron provides ground reconnaissance and surveillance capabilities. These capabilities include mounted reconnaissance platoons and mobile long-range surveillance teams. The network support company provides the communications backbone for the BFSB. This backbone allows the BFSB to communicate throughout the supported headquarters' AO and to conduct intelligence reach by accessing intelligence from organizations anywhere in the world. The brigade support company provides sustainment support to organic BFSB units. Based on the factors of METT-TC, commanders can tailor the BFSB for the mission and the AO. This involves providing the BFSB with additional assets before deploying, task-organizing assets to the BFSB from the supported headquarters, or providing theater-level assets to reinforce the brigade's collection capabilities. In stability operations, for instance, the BFSB may organize with additional human intelligence units. Aviation attack reconnaissance units and extended-range UAS from the combat aviation brigade, and potentially additional ground reconnaissance units—to include specialized engineer and chemical, biological, radiological, and nuclear (CBRN) reconnaissance element—may be OPCON to the BFSB.

1-36. The BFSB may control significant ground and air reconnaissance capabilities; however, the BFSB rarely conducts security operations for the supported headquarters. When sufficiently augmented, a BFSB may conduct a screen. When the supported headquarters requires guard, cover, area security, and route security operations, it assigns the missions to BCTs, or in the case of the latter two operations, to a MEB. In some operations, the threat will compel the supported headquarters to maneuver combat units to fight for information and develop the situation. If so, the division will assign the mission to a BCT or a combat aviation brigade.

1-37. The commander focuses the BFSB's collection efforts through two means—the assignment of an AO to the BFSB and the echelon ISR plan. The ISR plan is a collaborative effort within the supported headquarters staff with the G-3 and G-2 as the leads. This plan focuses the BFSB by clearly defining the PIR and prioritizing other information requirements for collection. The BFSB commander then has greater flexibility to allocate and, when necessary, reallocate and reposition resources to answer these information requirements. In some cases, the PIR will exceed the BFSB's organic collection capability. In such cases the supported echelon headquarters can augment the BFSB capability, assign collection to BCTs, or accept risk given the focus and priorities established by the echelon commander.

1-38. Commanders assign AOs to their BCTs and the MEB. These brigades conduct reconnaissance and surveillance within their AOs. This allows the BFSB to focus its resources in echelon unassigned areas. When commanders assign the BFSB an AO, it oversees terrain management, movement control, fires, and airspace command and control as outlined in FM 3-90. It has limited ability to provide security unless augmented. Supported echelon's staff and other units must understand this limitation. The BFSB rarely takes responsibility for infrastructure development or stability operations in the AO since it has limited ability to plan and conduct these operations.

1-39. The BFSB has the capability to reinforce the collection capability of other types of brigades. Such reinforcement occurs when the BFSB augments the other brigades with counterintelligence and human intelligence teams. These teams come from the BFSB's military intelligence battalion. The teams are attached or OPCON to individual brigades depending on the situation. The BFSB can also augment brigades with UASs, signals intelligence, mounted ground reconnaissance, or mobile surveillance teams. For instance, since the MEB has no organic reconnaissance assets, the division commander could direct the BFSB to attach a mounted troop and several long-range surveillance teams to the MEB. These teams would help conduct line of communications surveillance if the MEB has a large AO with several lines of communications to monitor.

1-40. The BFSB staff will assess the information collected and developed by BFSB assets to ensure it satisfies tasked information requirements. The BFSB staff passes all the information to the supported headquarters for processing and dissemination. The staff also posts information to a distributed database that allows access to commanders, Soldiers, and analysts. The BFSB will collaborate with impacted BCTs to provide all relevant information directly to them. If the information is critical to a specific brigade, the staff also reports directly to that brigade. For example, a brigade's PIR is sent to the supported headquarters as a request for information. The supported headquarters adds the brigade's PIR to its PIR list for collection by the BFSB. Once the BFSB collects the information, it reports it directly to the requesting brigade as well as the supported headquarters that assigned the task.

1-41. The result of BFSB collection activities will often cue other actions. As the BFSB collection effort identifies potential targets, the BFSB provides this information with the supported headquarters, and appropriate fires brigade, CAB, and BCTs. Since most intelligence analysis capability resides with the G-2 staff, the supported headquarters develops target handoff criteria in coordination with the other brigades in the division. For instance, the BFSB may locate a high-value target and pass the target to the fires brigade or the CAB to engage if the target is within an unassigned portion of the division AO. Alternatively, the BFSB passes off the target to a BCT if the target is located in the BCT's AO.

### ***Fires Brigade***

1-42. The fires brigade differs from the previous division artillery design. The fires brigade performs tasks previously executed by division artillery, field artillery brigades, and corps artillery. The fires brigade conducts combined arms operations to provide fires in support of the commander's operational and tactical objectives. The fires brigade executes most Army and joint fires in unassigned areas within the division AO. It also provides reinforcing fires in support of BCT operations. It can use Army and joint surface and air delivered fires as well as incorporating special operations forces, electronic warfare, and airspace command and control elements. The fires brigade may provide support to Army, Marine Corps, or multinational higher headquarters. The fires brigade gives the supported commander a headquarters to conduct strike, counterfire, and reinforcing fires throughout the supported headquarters AO.

1-43. Fires brigades differ from AOE field artillery organizations in their ability to reconnoiter, detect, and attack targets and to confirm the effectiveness of their fires. They have networked intelligence, robust communications, and systems that facilitate effective fires. The fires brigade can be a supported or supporting unit and provide and coordinate joint lethal and nonlethal fires including electronic warfare. Fires brigades also have the necessary fires and targeting structure to effectively execute the entire decide, detect, deliver, and assess process. The fires brigade provides the following:

- Force field artillery headquarters for the supported headquarters.
- Strike and counterfire for the supported headquarters.
- Close reinforcing fires in support of the supported headquarters BCTs.
- Fires, counterfire, UAS, and counterbattery radar coverage for brigades it is supporting.
- A C2 headquarters for the full complement of Army and joint lethal and nonlethal fires.

### ***Combat Aviation Brigade***

1-44. Combat aviation brigades support the operations of the headquarters to which it is assigned with task-organized aviation teams. This can be a JFLC, a corps, or a division. Based on priorities and missions, the CAB can also collaborate directly with a supported BCT or other brigade for operational details of the support required.

1-45. The CAB, containing both manned and unmanned systems, is tailorable to the mission and can support multiple BCTs. CABs can be configured as heavy, medium, or light in accordance with the numbers and types of assigned aircraft. A CAB typically conducts the following missions:

- Reconnaissance.
- Security.
- Attack.

- Air assault.
  - Air movement.
  - C2 support.
  - Aeromedical evacuation.
  - Personnel recovery.
- Downed aircraft recovery.

1-46. The CAB receives mission orders from the supported headquarters. The CAB commander task-organizes available aviation resources into mission packages. Either a supported brigade or the CAB controls these packages based on the factors of METT-TC.

1-47. The CAB has an organic air ambulance company in the general support aviation battalion for aeromedical evacuation capable of supporting 24-hour operations. This company consists of a company headquarters and four forward support MEDEVAC teams with three aircraft each. The company can be individually or group deployed in support of tactical, operational, and strategic missions encompassing full spectrum operations.

1-48. The CAB can conduct attacks in support of the supported headquarters' concept of operations. Attacks may involve rapidly task-organizing assets across the supported echelon. During its attacks, the CAB will normally have long-range fires assets in direct support from the fires brigade and BFSB reconnaissance assets for planning and execution. The CAB will retain this direct support for the duration of the attack. However, the CAB will release control of the BFSB assets once its own reconnaissance capabilities work.

1-49. The CAB executes attack missions for the BCTs. These missions involve conducting integrated air-ground operations to close with and destroy the enemy. These missions require a high level of air-to-ground coordination. The brigade aviation element is the cell in the BCT that does this coordination. The CAB should attempt to develop a habitual relationship between its attack units and their supported BCTs. This relationship should begin to form during Army force generation (ARFORGEN).

1-50. Aviation support allows the ground commander to extend the tactical reach of maneuver forces, particularly in complex terrain. Aviation assets help control the tempo of the fight by providing a force capable of rapid reaction to sudden changes. The attack reconnaissance helicopters provide the BCT extended acquisition range and lethality.

1-51. The CAB may also execute screening missions. The CAB may receive ground maneuver and joint assets and capabilities to carry out these missions. It supports other security operations with aviation forces including BCTs assigned a screen, guard, or cover mission. For screen, guard, and cover missions, the CAB may provide attack reconnaissance, heavy lift, assault, and MEDEVAC assets under the OPCON of maneuver BCTs. The CAB can also support area security operations—including route and convoy security operations—conducted by the MEB or BCTs.

1-52. The aviation force structure also includes theater aviation brigades under the theater aviation command. (See chapter 3.) Theater aviation brigades differ from combat aviation brigades in that they do not have attack aircraft.

### ***Maneuver Enhancement Brigade***

1-53. The MEB receives and controls forces to provide protection and mobility to prevent or mitigate effects of hostile action against divisional forces. While the MEB has no direct antecedents in today's force structure, it combines functions previously performed by the division rear operations center, division engineer brigade, and other division-level engineer, military police, and chemical assets. MEBs preserve freedom of movement and maneuver for operational and tactical commanders. These brigades control terrain and facilities and prevent or mitigate hostile actions or weather effects on the protected force. A MEB is a combined arms organization that is task-organized based on mission requirements. It has a combined arms staff and C2 capabilities that suit it for many missions. These brigades typically control combinations of several different types of battalions and separate companies, such as military police, chemical defense, civil affairs, engineer, explosive ordnance disposal, and combined arms battalions. In unusual circumstances,

the MEB may include air and missile defense units. When more than two similar functional battalions are assigned to the same MEB, the MEB commander and the supported commander must make an assessment to see if the situation requires the assignment of another MEB or functional brigade headquarters.

Typical missions sets for a MEB are listed below:

- Conduct CBRN operations.
- Provide explosive ordnance disposal support.
- Conduct area security, local security, and line of communications (LOC) security operations.
- Control airspace above its area of operations.
- Construct, maintain, and sustain LOCs.
- Coordinate direct and indirect fires in support of MEB operations.
- Conduct combat and general engineering operations within assigned engineer force capabilities.
- Conduct internment and resettlement operations when assigned appropriate military police forces.
- Conduct limited offense and defense operations when assigned a tactical combat force (TCF).
- Conduct limited stability operations.
- Conduct civil support tasks in support of state or federal authorities (depending whether or not the brigade is in a Title 32 or Title 10 status), such as disaster relief, consequence management, or restoration of order.

1-55. The supported headquarters provides the MEB with protection priorities and continuously updated threat estimates. After carefully assessing self-protection capabilities of the supported headquarters subordinate units, the MEB commander allocates assets to meet the supported commander's priorities. There will never be enough capability to make the supported unit invulnerable to threats. Therefore, the MEB commander tries to balance the needs of acceptable risk, self-defense, passive protection measures, and proactive elimination of threats.

1-56. The MEB is normally assigned an AO in which it performs its missions. Normally, that AO is also the supported echelon's support area. **A support area is a specific surface area designated by the echelon commander to facilitate the positioning, employment, and protection of resources required to sustain, enable, and control tactical operations.** The support area normally includes the echelon's main supply routes. For each echelon, the support area is annotated with the echelon size, such as a brigade support area or a division support area. If the supported echelon has more than one MEB assigned, then the support area can be split into two AOs, one for each MEB.

1-57. When assigned an AO, the MEB performs terrain management, movement control, clearance of fires, security, personnel recovery, ISR, stability operations, and infrastructure development. When the MEB is assigned an AO, it is not responsible for the supported echelon's unassigned areas. For example, movement control of sustainment operations in the division AO as a whole stays the division transportation officer's function even when it passes through the MEB AO. The division transportation officer coordinates those movements with the MEB.

1-58. The MEB is organized and trained to execute selected area security missions including route and convoy security. It is not designed to conduct screen, guard, and cover operations. These operations are assigned to BCTs, or in the case of screening operations, possibly to a CAB. The MEB can use a maneuver battalion as a TCF. When the situation requires, the MEB executes limited offensive and defensive operations, using response forces and the TCF against level II or III threats. The TCF may include not only ground maneuver, but also aviation and fires assets. Commanders should use a BCT when the situation requires a TCF of two or more ground maneuver battalions.

1-59. The MEB does not supplant unit self-defense responsibilities. Units remain responsible for self-protection against level I threats. The MEB provides forces to respond to level II threats in its AO. If the brigade is assigned an area security mission, it should be task-organized with a TCF. When this occurs, that TCF can respond to level III threats. For example, those portions of the division's supporting sustainment brigade positioned in the MEB AO remain responsible for their own unit security and base and base cluster

defense operations. The MEB oversees area, not local, security operations in its AO. This includes response and tactical combat force operations directed against level II and III threats.

1-60. The MEB conducts operations in areas external to its previously assigned AO when directed to do so by its supported commander. This requires the supported headquarters to either temporarily change boundaries or have some other headquarters retain AO responsibilities for the terrain on which the MEB units are tasked to conduct operations. For example, when operating in noncontiguous AOs, a division commander could temporarily change boundaries. This change allows the MEB to conduct route security or convoy security operations along a ground LOC between the division sustainment area and the AO of a subordinate BCT.

1-61. The supported MEB higher headquarters can assign missions for assets assigned or attached to a MEB executed outside its AO, such as CBRN defense and explosive ordnance disposal assets. This requires careful coordination between the tasked unit, the MEB headquarters, and the headquarters of the unit in which the mission occurs. For example, the preferred method after assessing the situation, involves a division headquarters cutting a fragmentary order. This order directs the MEB to provide an explosive ordnance disposal capability in direct support of a BCT for a specified period. This capability allows the BCT to inventory safely a newly discovered ammunition storage facility. The order authorizes direct liaison between the MEB and the BCT since the MEB will coordinate numerous tactical and sustainment items with the BCT. These items can include movement routes and times, link-up points and times, recognition measures, location of supply points, maintenance collection points, medical facilities, and communications-electronics operating instructions. Alternatively, the division could use the MEB as a force provider. The division could re-task-organize the MEB, and the BCT could issue a fragmentary order detaching an explosive ordnance disposal team from the MEB and attaching it to the BCT for the duration of the mission.

1-62. The number of MEBs supporting a headquarters depends on the factors of METT-TC. A JFC may place a MEB in support of another Service or functional component, such as the Marine Corps forces. This brigade can then provide area security for a Marine air-ground task force or the joint force air component, to secure an airbase. A MEB may be placed in support of multinational forces.

1-63. In addition to the MEB, the supported headquarters may have been tailored with functional brigades to support the force as a whole or to carry out a particular task. The MEB may need to provide support to these brigades. For example, in addition to a MEB, a division might receive a military police brigade to control dislocated civilians and handle detainees. In this case, the MEB may be tasked to provide general engineering support to the military police brigade to construct detainee facilities.

### ***Sustainment Brigade***

1-64. Sustainment brigades are subordinate units of the theater sustainment command. They consolidate functions previously performed by corps and division support commands and area support groups into a single echelon and provide C2 of the full range of logistic operations. When supporting theater forces, the sustainment brigade and the supported force normally establish a support relationship. Under certain factors of METT-TC, a sustainment brigade could be placed OPCON to a division headquarters for a specified operation, such as an exploitation or a pursuit operation. However, a division headquarters does not routinely have a command relationship with its supporting sustainment brigades. All sustainment brigade headquarters have identical organizations. Their core competency is C2 of logistic operations, including life support activities, distribution management, and movement control as an integral component of the theater distribution system. Their mission determines the mix of functional and multifunctional subordinate battalions under their control. They employ satellite- and networked-based communications that enable C2; visibility of the distribution system; and identification of support requirements. Organized appropriately, they perform theater opening, distribution, and sustainment functions.

1-65. Sustainment brigades and their subordinate units will rarely be assigned an AO. Their staffs are not configured to perform the standard responsibilities of having an AO. Responsibilities include terrain management, movement control, clearance of fires, security operations, stability operations, personnel recovery, ISR, and environmental management. However, sustainment brigades have self-protection capabilities,

and their commander can be assigned base and base cluster commander responsibilities within an AO assigned to either a BCT or a MEB. A rear operations center may be used with a sustainment brigade headquarters to facilitate the organization and supervision of bases and base clusters when the tactical situation warrants.

1-66. Theater opening sets conditions for effective support and lays the groundwork for subsequent expansion of the theater distribution system. Critical tasks for theater opening include operational sustainment C2 with reach capability and in-transit visibility; theater reception support, staging, onward movement; distribution operations; life support; contracting support; and initial theater sustainment. In the past, ad-hoc organizations—lacking specific structure or training to perform this function—conducted C2 of these tasks.

1-67. Theater distribution enables decisive action by building and sustaining combat power according to the joint force commander's priorities. Theater distribution is a critical function of multifunctional sustainment operations that includes air, land, and sea operations; management of materiel; management of assets; developing requirements and priorities; and retrograde functions critical to the repair of vehicles, equipment, weapons, and components. Critical tasks in this function include synchronizing multimodal distribution operations across an AO to support joint force commander requirements; maintaining visibility of the distribution system; and managing distribution.

1-68. The sustainment function consists of related tasks and systems that provide support and services to ensure freedom of action, extend operational reach, and prolong endurance. It includes providing support to forces operating in or passing through a specified AO. It encompasses the provisioning of personnel services, logistics, force health protection, and other support required to sustain combat power. All sustainment brigades have the same general responsibilities: to conduct sustainment operations in an assigned support area. However, depending on the support relationship to units at the operational or higher tactical level, the role of the sustainment brigade can differ. A sustainment brigade providing operational-level support deals with supporting maneuver, deployment, redeployment, and base support. A sustainment brigade supporting a division deals with providing sustainment and distribution support to its supported units.

1-69. During operations, divisions will establish a battle rhythm that balances combat and sustainment operations. This will combine mission staging operations and replenishment operations to sustain forces. Mission staging is a deliberate operation designed to refit and replenish BCTs by cycling them into and out of contact. Two types of rapid replenishment operations complement mission staging operations: sustainment replenishment operations and combat replenishment operations. These operations maintain the tempo and extend the endurance of the force. Wherever possible, sustainment operations capitalize on distribution-based logistics. In this case sustainment from other sources meets the unit's requirement for supplies, fuel, ammunition, maintenance, and materiel. Intratheater, intertheater, and continental United States (CONUS) sources push resources directly to the consuming unit based on its demand.

## **OTHER BRIGADES AND UNITS**

1-70. A mix of functional brigades and units will remain in the Army force structure for the foreseeable future. These functional brigades will normally be assigned or attached to theater-level commands addressed in chapter 3. Examples can include military police, engineer, air and missile defense, signal, medical, CBRN defense, and civil affairs. Functional brigades may be attached or OPCON to the ARFOR headquarters, normally a division. They may also be placed under OPCON of the joint force land component commander. Normally theater-level C2 organizations will augment these functional brigades if they are operating directly under a JFC and not as part of theater army.

1-71. The theater army may allocate functional brigades to a JFLC, corps, or division to support the force as a whole or to carry out a particular task. For example, in addition to a MEB, a division might receive a military police brigade headquarters and several military police battalions to control dislocated civilians and handle detainees. Figure 1-9 provides some examples of functional brigades reinforcing a division.

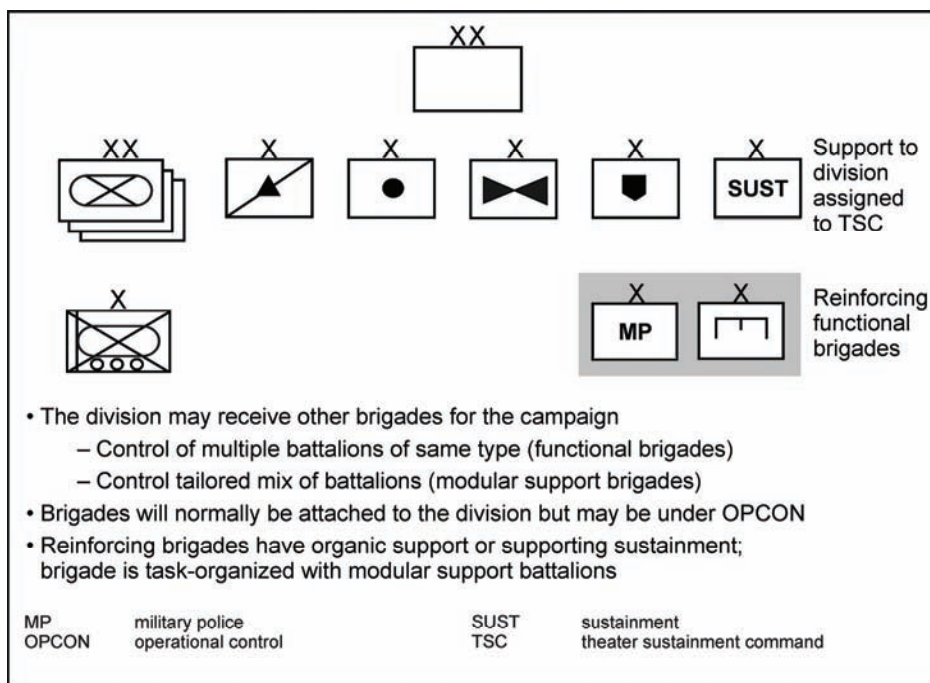

Figure 1-9. Example of additional brigades attached to a division

## MODULAR ARMY FORCES CONTROLLED BY OTHER SERVICES

1-72. The Army's modular design allows other Service headquarters to receive and employ Army brigades directly, without an intervening Army headquarters. Figure 1-10 on page 1-22 illustrates a MEB TACON to a Marine expeditionary force. The MEB headquarters in this example serves as the common Army headquarters of those Army battalions and separate companies TACON or otherwise supporting the Marine expeditionary force, such as the signal battalion providing network operations support. Commanders take care to avoid exceeding the Army brigade's span of control. In this example, the theater army continues to exercise ADCON for the MEB brigade. Other examples may include TACON of a missile-heavy fires brigade to the joint force air component commander, or a sustainment brigade providing direct support to a joint special operations task force.

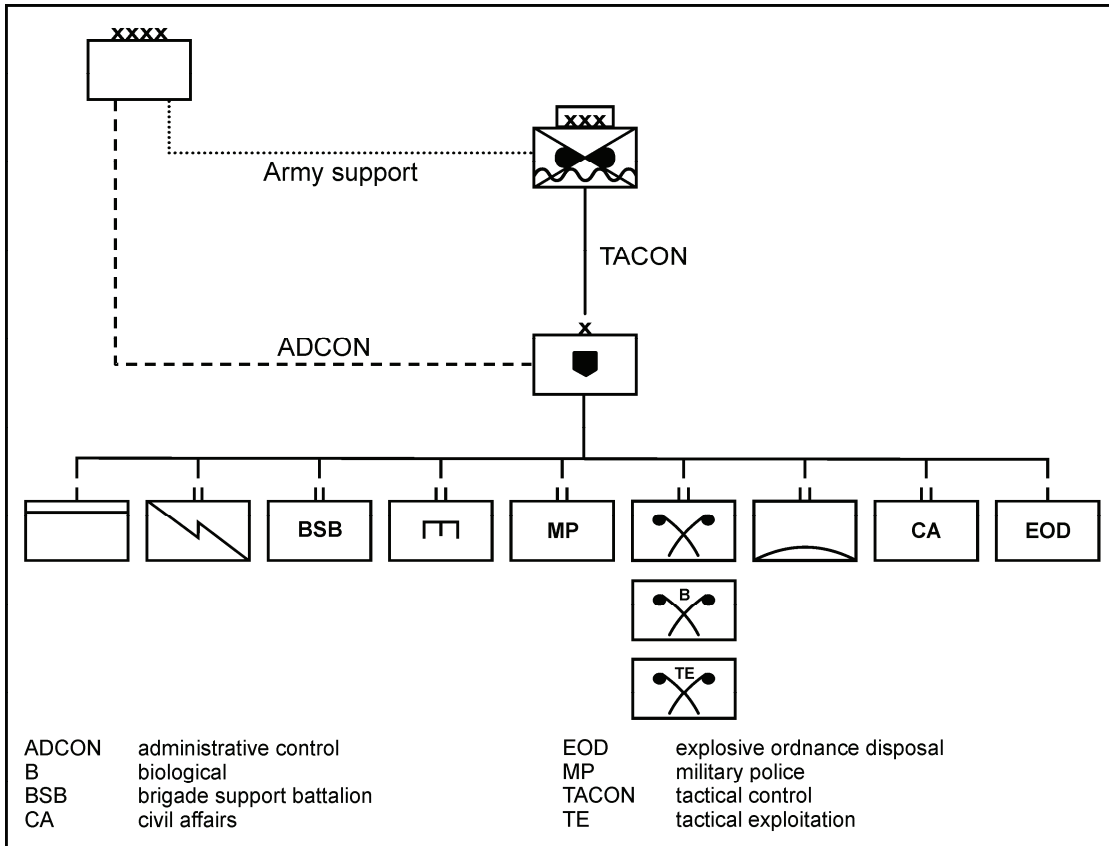

Figure 1-10. A MEB under TACON to a Marine expeditionary force



## Chapter 2

# Modular Force Organization

This chapter discusses factors commanders consider when organizing modular forces. It addresses command relationships, habitual association of units, force tailoring, and task organization. This chapter assumes the validity of the operational framework and concepts in FM 3-0.

### ORGANIZING THE FORCE

2-1. The Secretary of Defense produces the “Forces for Unified Commands” memorandum. This memorandum assigns all operational Army forces from the Services to combatant commanders. Combatant commanders exercise combatant command over these forces. Army forces assigned to each combatant commander are under the administrative control (ADCON) of the Army Service component command (ASCC) for that combatant command. Until Army forces are placed under operational control (OPCON) of a subordinate joint force commander, the combatant commander normally exercises operational control over them through the ASCC.

2-2. Selected Army units may be assigned to a combatant command. However, their Service chain of command may be routed through an Army command or direct reporting unit (DRU), rather than the ASCC for that combatant commander. This routing specifies the administrative authorities necessary for an Army headquarters to execute Service ADCON functions. Redistributing ADCON responsibilities does not infringe on the combatant command (command authority) vested by law in the commanders of combatant commands. The Department of the Army (DA) adjusts ADCON to increase the ability of the Army command or DRU to manage and support the global force. The combatant commander still exercises combatant command over these forces, including operational control. The ASCC for the combatant commander may have responsibility for specific ADCON requirements. This responsibility comes from Army orders or a memorandum between the respective Army headquarters.

2-3. Supporting combatant commanders transfer ready forces to meet a supported combatant commander’s requirements for specific missions. United States Joint Forces Command (USJFCOM)—through its ASCC, United States Army Forces Command (FORSCOM)—provides most Army forces. (USJFCOM uses the Global Force Management model to distribute ready forces globally.) Within the modular Army, the organization of forces is dynamic at all levels. Nowhere is this more evident than the shift from the division echelon as the Army’s senior fixed tactical echelon to a brigade-based force. Implementing a fully modular force requires Army and joint commanders to understand how the organization of the force. It also requires commanders to view strategic, operational, and tactical organization of the force as inseparable from employment of the force. Army forces are organized and reorganized continuously according to strategic, joint, and mission requirements.

2-4. The Army supports national strategy by organizing, training, equipping, and assigning forces to various headquarters. The National Military Strategy, the Joint Strategic Capabilities Plan, and the geographic and functional combatant commanders’ enumerated operational requirements drive the size and capability mix of the force. This strategic Army role of providing forces to meet global requirements is called force generation. The Congress, Secretary of Defense, and the Chairman of the Joint Chiefs of Staff make decisions regarding force size and capabilities. DA then establishes manning, training, and readiness cycles; assigns forces to headquarters; and manages modernization.

2-5. However carefully the Army may plan strategically, actual requirements for forces on campaign will always differ from planning figures. In consequence, the theater army commander recommends the appro-

priate mix of forces (force packages) and the deployment sequence for forces to meet the geographic combatant commander’s (GCC’s) requirements. This force tailoring determines the right mix and sequence of forces for a mission.

2-6. Within these force packages, Army commanders organize groups of units for specific missions. They reorganize for subsequent missions when necessary. Allocating available assets to subordinate commanders and establishing their command and support relationships is called task-organizing. The ability of Army forces to tailor and task-organize gives them extraordinary agility. It allows operational- and tactical-level commanders to organize their units to make the best use of their available resources. This provides them the capability to rapidly to task-organize their available means—Army forces—and shift emphasis rapidly between offensive, defensive, and stability or civil support operations.

2-7. Figure 2-1 provides a general overview of the process. It also provides some sense of the time involved. Strategic organization involves cycles of 3-to-6 years based on Army manning and readiness cycles. Force tailoring spans the duration of the campaign. It anticipates each phase of the campaign, extending to several months or longer for protracted operations. Task organization is a temporary organization of the force. Task organization is tactical in nature and covers the duration of a mission, often in less than 24 hours but perhaps days in length. The relative duration is important because commanders must adjust ADCON responsibilities carefully in a modular force to ensure that they meet training, readiness, sustainment, and Soldier requirements.

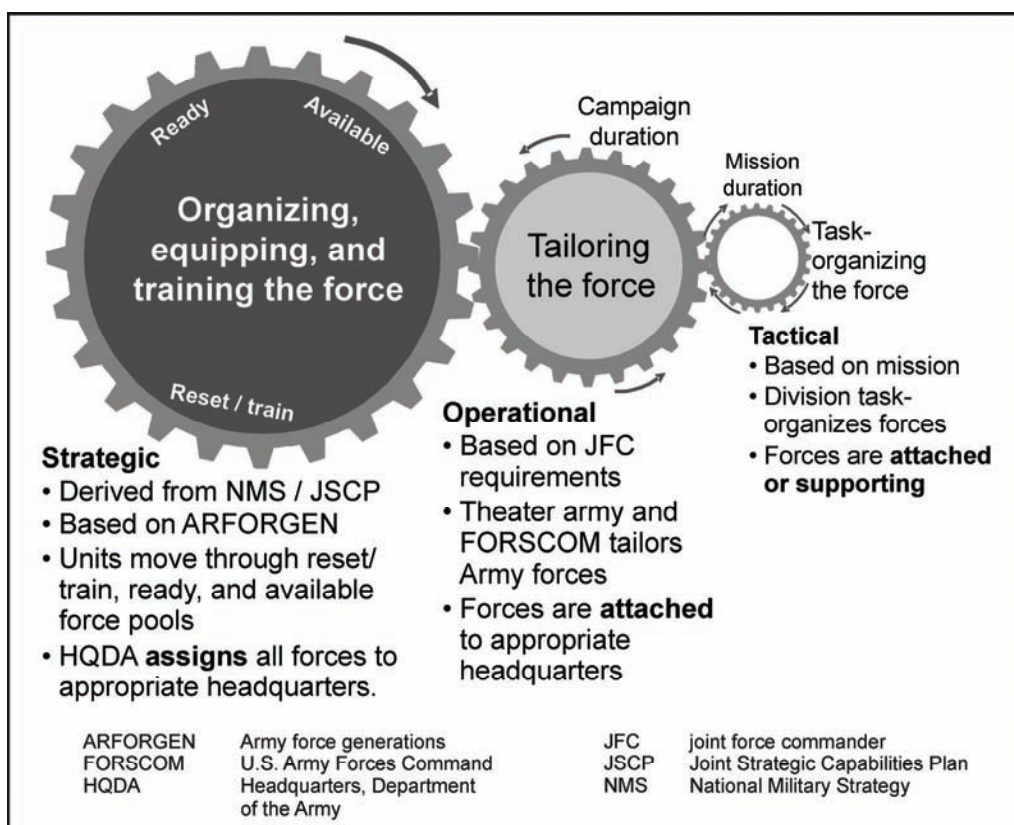
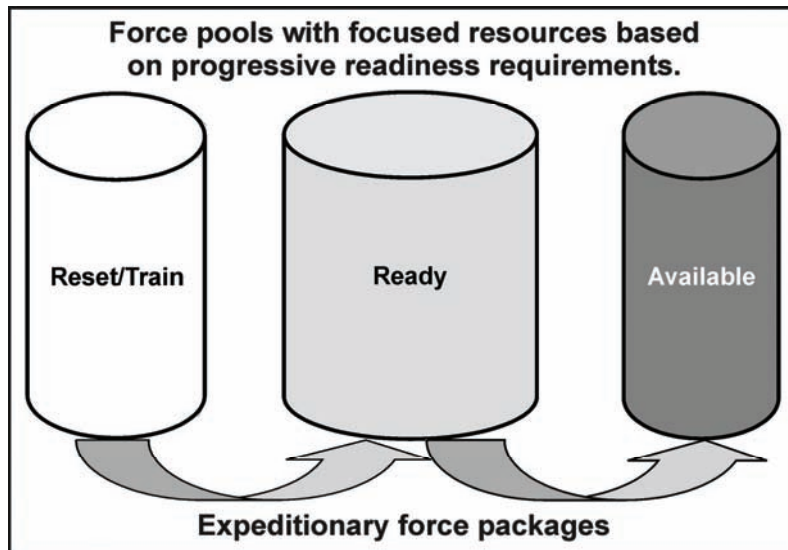

Figure 2-1. Organizing the force

## UNDERSTANDING THE FORCE POOL

2-8. Army force generation (ARFORGEN) is the structured progression of increased unit readiness over time. It results in recurring periods of availability of trained, ready, and cohesive units prepared for opera-

tional deployment in support of civil authorities and combatant commander requirements. ARFORGEN is an Army process. It applies to all components across the operating and generating force. The finer points of ARFORGEN are still being revised based on lessons learned, but the basic elements are as follows: Modular Army brigades go through a three-phased readiness cycle. Conceptually for most Regular Army modular brigade combat teams (BCTs) and support brigades, this cycle lasts three years. The conceptual cycle lasts six years for United States Army Reserve (USAR) and Army National Guard (ARNG) component brigades. This concept has not been realized to date. The ARFORGEN cycle takes each unit through three “force pools,” designated “reset/train,” “ready,” and “available.” (See figure 2-2.) Throughout ARFORGEN, commanders attempt to stabilize assigned personnel. Once assigned to a unit, personnel stay with the unit until the end of that readiness cycle.



**Figure 2-2. The ARFORGEN model**

2-9. In the continental United States (CONUS), all Regular Army general purpose or conventional BCTs, support brigades, and functional brigades are assigned to the FORSCOM. (USAR and ARNG brigades have different chains of command prior to mobilization, but after mobilization become part of the FORSCOM force pool.) FORSCOM establishes a command relationship between these brigades and a division headquarters. In turn, CONUS-based division headquarters also are part of the FORSCOM force pool. CONUS-based division headquarters include support and functional brigades not assigned to a division headquarters, and those theater army elements not forward deployed or otherwise assigned to another Army command. Currently FORSCOM uses its First Army headquarters as its command and control headquarters for its force pool.

2-10. Units enter the reset/train force pool when they redeploy from long-term operations or complete their planned deployment window in the available force pool. Generally units in reset/train are not ready to conduct major combat operations. However, they may be used to provide defense support to civil authorities including homeland security, humanitarian assistance, disaster relief, and consequence management operations. In reset, units perform recovery, reconstitution, and equipment reset and recapitalization; receive and integrate new personnel; execute their institutional training support plan; and complete change of command property accountability actions. Reset day marks the transition from reset to collective training focus. Reset day sets the target date to man, equip, and resource the unit to required levels. Then the unit can execute the unit training plan and begin effective collective training to achieve designated mission- or core mission-essential task list (METL) capability. FORSCOM recommends unit reset day. For ARNG and USAR units, FORSCOM coordinates with the National Guard Bureau and the Office of the Chief of the Army Reserve. Headquarters, DA approves the day, and an official order establishes it. After reset day, units conduct individual and collective training focused on their core METLs. If the units are designated to deploy on an ac-

celerated cycle and have derived a theater-specific METL, they focus on other training. Approved joint contingency plans drive these directed METLs. Individual units achieve designated capability levels to move from reset/train into the ready portion of the force pool.

2-11. The ready portion of the force pool consists of those units assessed as ready to conduct higher-level collective training and prepare for deployment. Training and preparation in the ready force pool focuses on mission-essential training. This training aligns deployment expeditionary force packages with ready expeditionary force packages. Deployment packages are sets of modular units including a higher headquarters—normally a division headquarters—identified and scheduled to deploy to an ongoing operation or campaign. FORSCOM tailors each deployment package for a particular mission. Ready expeditionary force packages consist of forces that train and prepare for a broad set of operational requirements. FORSCOM strategically tailors these forces under a division headquarters based on the best task organization for training. (Often this tailoring results in packages that contain BCTs wearing different division patches from the division headquarters to which they are attached.) In the event that a crisis requires additional forces, FORSCOM may surge units in the ready force pool into a deployment expeditionary force package. Both sets of force packages receive METLs and other guidance through FORSCOM from the theater army commander scheduled to use them. Direct liaison authority may exist. Approved joint contingency plans and combatant commander exercise programs also drive these METLs.

2-12. The available force pool consists of those modular forces and headquarters deploying for an ongoing operation (deployment expeditionary force packages), or available for immediate alert and deployment to a contingency (ready expeditionary force packages). Ready packages become contingency expeditionary force packages when they move into the available force pool. Units in a contingency package may be reassigned to a deployment package or may deploy with their assigned division headquarters as part of a new ready package as part of a contingency operation. At the end of their time in the available force pool, units rotate back into the reset/train pool, and the cycle begins again.

2-13. Although all units in the available portion of the force pool can be used, all units in this portion of the ready force pool will not all have the same employing (gaining) headquarters. Nor will they necessarily have a habitual association with their deploying headquarters. This increases the need for competent liaison between the two organizations and standardized standing operating procedures. As units are alerted and deployed for missions, their command relationships with their employing headquarters vary according to the strategic, operational, and tactical circumstances. Difficult as this is at the BCT level, modular components of supporting brigades require additional efforts.

2-14. The Army staff, FORSCOM, and other Army commands determine the deployment, ready, and contingency expeditionary force packages. Packages rotate on a cyclical basis (typically on a bi-annual basis). These periodic strategic assessments determine unit alignments with higher headquarters and force packages (sourcing); training support plan and training priorities; resources in terms of funding and equipment packages; and finally, published plans and orders.

## COMMAND RELATIONSHIPS

2-15. Modular force employment required the Army to adjust its doctrinal concepts of command and support relationships. Command relationships define superior and subordinate relationships between units and their commanders. They specify a chain of command. In so doing, they unify effort and enable commanders to employ subordinate forces with maximum flexibility. Staff officers do not have operational control authority over supporting units. Tasks to supporting units are provided only through operation and fragmentary orders signed by the G-3 “for the commander.” They are not given directly from a staff officer to a supporting unit. FM 3-0 defines these revised relationships.

## ORGANIZING THE MODULAR FORCE

2-16. Modular forces, unit manning, and rebalancing of forces among the Regular Army, ARNG, and USAR forces affect the way Army forces prepare for operations, as well as command relationships. Strategic organization balances modernizing the force, unit manning requirements, and operational requirements.

This complex interaction requires detailed management by Headquarters DA, Army commands—particularly FORSCOM—and Army DRUs.

## **STRATEGIC ORGANIZATION**

2-17. Forces assigned to combatant commanders are identified in the “Forces for Unified Commands” memorandum signed by the Secretary of Defense as described in JP 1. All units of the modular Army are assigned per the “Forces for” memorandum. These forces are the Army operating force. Most Army operating forces are assigned to USJFCOM and subsequently to FORSCOM. Those forces not assigned to a combatant commander remain assigned to the DA. This is the Army generating force. DA primarily organizes these forces under Tables of Distribution and Allowances.

2-18. Within the joint assignment of forces, all units of the modular Army are organic or assigned to an Army higher headquarters. Every battalion is either organic to or assigned to a brigade or BCT. Certain forces are organic to BCTs and support brigades. For example, the combined arms battalions and fires battalion of the BCT are organic to the BCT. Normally organic relationships remain unchanged except by table of organization and equipment (TOE) redesign, with changes approved and documented by the DA. Forces organic to the BCT may be task-organized temporarily to another brigade when deployed but remain part of the BCT. The support brigades include a mix of assigned and organic units. The assigned brigade headquarters has ADCON responsibilities for its assigned units, just as it does for its organic units. However, assigned forces are detached from one support brigade and attached to another as part of the force tailoring process. The DA, Army commands, DRUs, and the ASCCs determine the assignment of battalions and separate companies to a particular BCT or support brigade.

2-19. Army commands, DRUs, and ASCCs attach each BCT or support brigade to a higher headquarters after they organize the BCT or support brigade. These headquarters include—

- Division.
- Theater army.
- Senior headquarters at an Army installation designated the senior mission commander by FORSCOM.
- Theater army major subordinate commands and brigades, such as the military intelligence brigade, theater sustainment command, signal command (theater), civil affairs command, and medical deployable support command.

2-20. Most BCTs and many support brigades are attached to a division headquarters. The mix and number of BCTs and support brigades attached to a specific division headquarters is determined by strategic planning considerations.

2-21. Certain brigades are attached directly to a theater army headquarters or to theater-level commands OPCON to the theater army. This is often the case for functional, theater-level organizations forward-based in a GCC’s area of responsibility (AOR). For example, normally all sustainment brigades in an AOR are attached to the theater sustainment command.

2-22. Brigades assigned by DA to DRUs support joint commands or provide support to both a theater army commander and to strategic agencies. These brigades can include the United States Army Intelligence and Security Command or United States Army Network Enterprise Technology Command (NETCOM)/9th Signal Command (Army) organizations. (The assignment of Army forces to Army commands and DRUs by DA differs from the allocation of Army forces to combatant commanders in the Joint Strategic Capabilities Plan.) Figure 2-3 on page 2-6 illustrates this case using a hypothetical military intelligence brigade, but several other unit types are assigned directly to DRUs. For forward stationed active duty units, some ADCON functions will belong to the theater army, but ADCON responsibilities, such as training, manning, and equipping, are specified by DA to the DRU. (The chains of command for Army National Guard and Army Reserve units and Soldiers are more complex.) The operational chain of command runs from the combatant commander through the ASCC or theater army to the brigade.

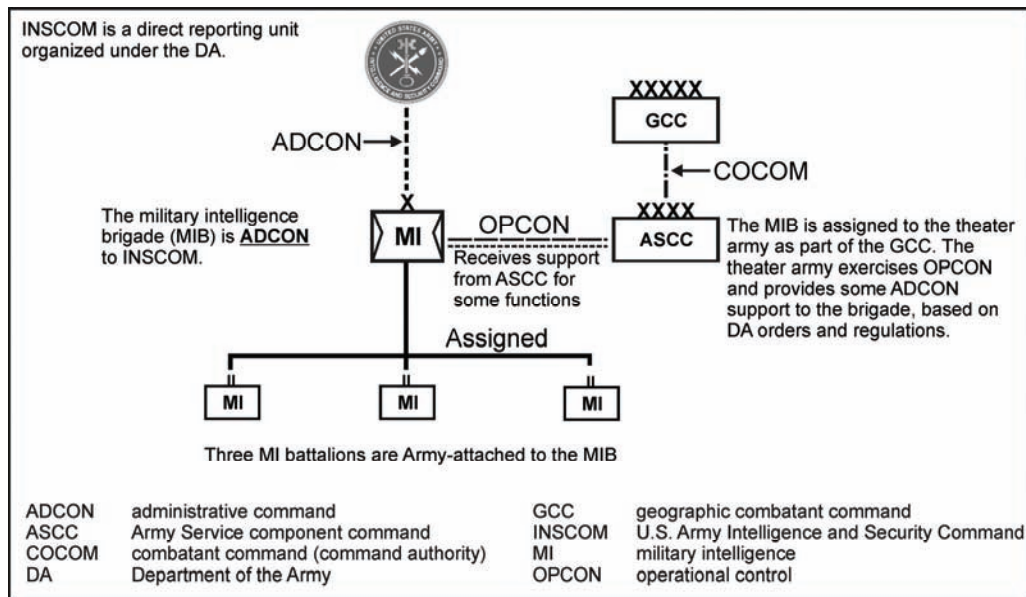

**Figure 2-3. Example of split ADCON relationship**

2-23. Figure 2-4 illustrates the organic structure and assignment of a BCT to its higher headquarters. This figure uses hypothetical designations for tactical units. (DA determines actual unit assignments and designations.) In this case, the 4th HBCT is assigned to the 3rd Division by a DA order. This could be the result of strategic realignment into a deployment expeditionary force package, or it could reflect the habitual association of the 4th HBCT with the 3rd Division as part of a ready expeditionary force package.

### FORCE TAILORING

2-24. The gaining theater army tailors modular Army forces for employment in campaigns, major operations, and other contingencies. Tailoring the force alters the command relationships established by the strategic organization of the force. The theater army commander, working for the GCC, determines the mix of forces and capabilities (to include command and control headquarters) required for a campaign. This can be done as part of the joint deliberate planning process or as a result of crisis action planning. Based on the GCC's request for forces, FORSCOM, a DRU, or another supporting theater army detaches the appropriate forces to the gaining theater army. The gaining theater army modifies the existing assignment relationships (when required) by attachment or OPCON of Army forces to one of the following:

- Theater-level command—such as a theater sustainment command or an Army air and missile defense command.
- Division.
- Brigade.

(In unusual circumstances, brigades flowing into an AOR can also be attached or placed OPCON to an available corps headquarters acting as an intermediate-level tactical headquarters.)

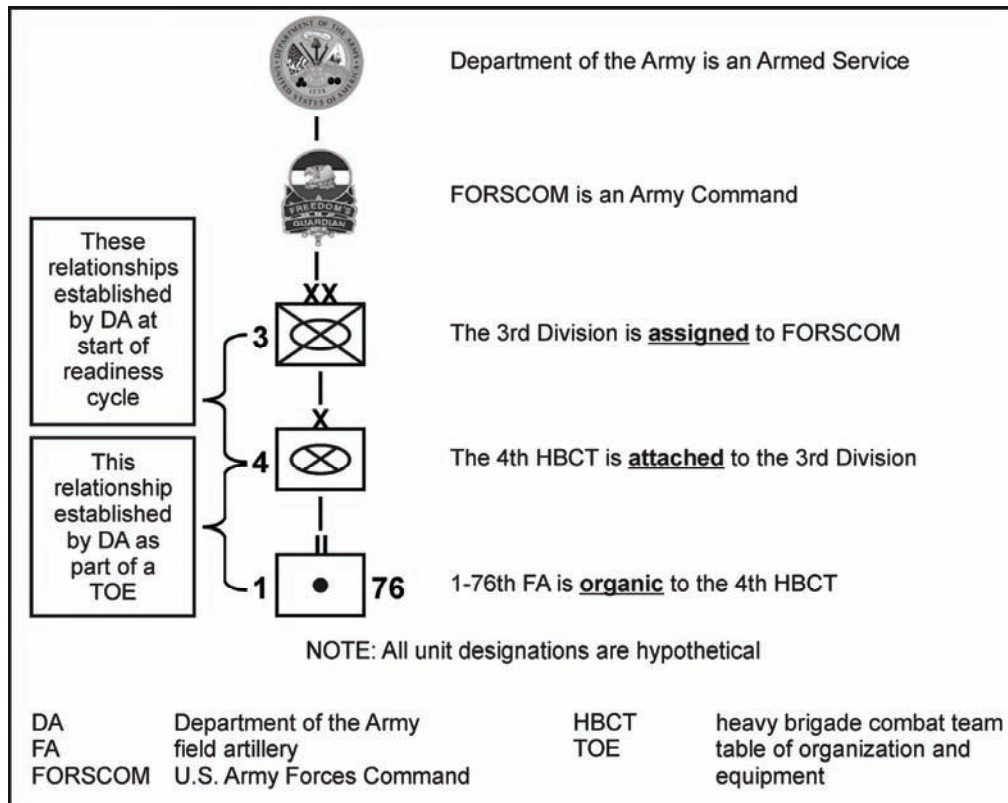

Figure 2-4. Strategic organization of a BCT in CONUS

2-25. Unless modified by a transfer of responsibility agreement, ADCON of Army forces passes to the gaining theater army, then to the headquarters of attachment during force tailoring. Figure 2-5 on page 2-8 uses a hypothetical situation to show how tailoring might change the organization of a modular brigade. U.S. Army Pacific (USARPAC) is the gaining theater army in this example. USARPAC receives the 3rd Division, which deploys with its attached fires brigade—the 75th Fires Brigade—as part of a deployment expeditionary force. Before it deployed, the 75th Fires Brigade consisted of two Multiple Launch Rocket System (MLRS) battalions, the 4-19th Field Artillery (FA) and the 3-34th FA, and one 155mm battalion, the 5-32d FA. For this campaign, the 3rd Division commander requires less MLRS capability, but more supporting cannon fire. Therefore, the USARPAC commander requests additional cannon battalions and directs the detachment of the MLRS battalion. The 1-32d FA (155 SP [self-propelled]) is attached to the 75th Fires Brigade while simultaneously detaching the 4-19th FA (MLRS) to another fires brigade in CONUS. FORSCOM decides which CONUS-based fires brigade to attach the detached MLRS unit. As tailored, the 75th Fires Brigade has a command relationship over the over the 1-32d FA, 5-32d FA, and 3-34th FA battalions. The tailored 75th Fires Brigade is in turn attached to the 3rd Division which has the doctrinal ADCON and operational authorities associated with that command relationship.

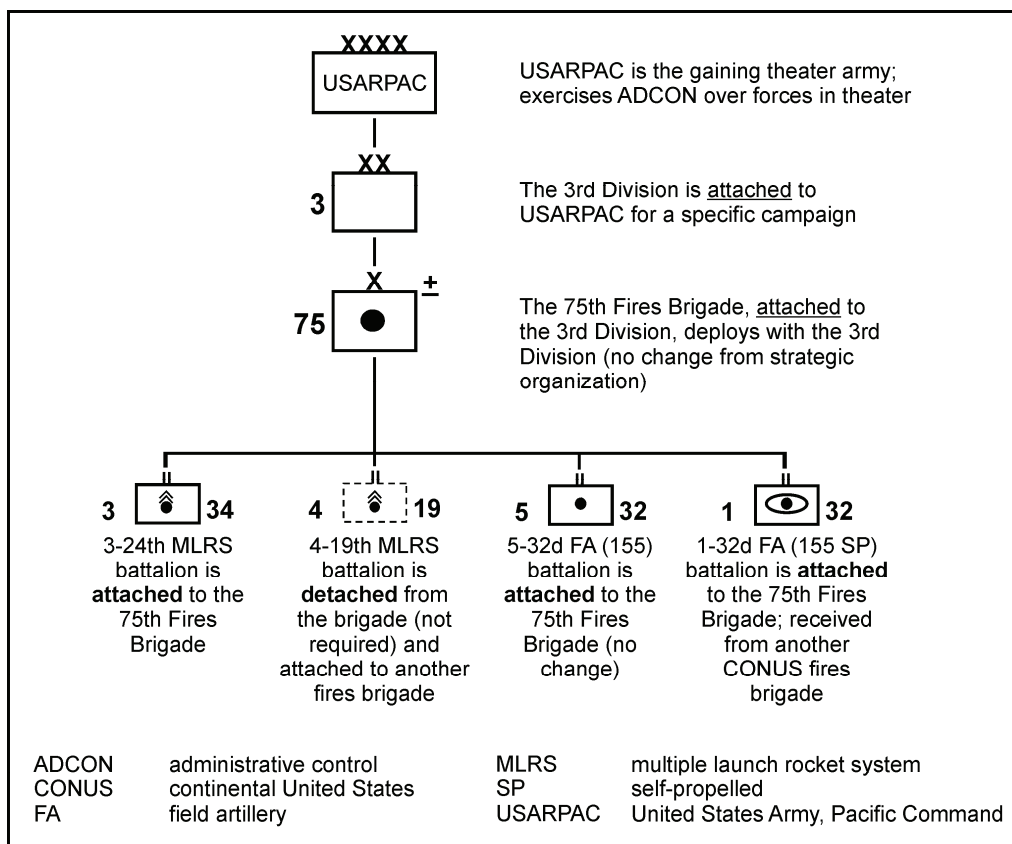

Figure 2-5. Example of force tailoring

## TASK ORGANIZATION

2-26. Army forces are task-organized to accomplish a mission. Theater army, division, BCT, and support and functional brigade commanders change subordinate unit command relationships and specify support relationships as required. Attached or OPCON units are task-organized under different headquarters as necessary to accomplish assigned and implied missions. Deciding to task-organize specific formations may reflect previously approved contingency plans or result from current planning efforts. As these missions end, units return to their parent headquarters or are further task-organized by the controlling headquarters. The gaining headquarters has only the authority and responsibility toward the task-organized element inherent in that doctrinal authority.

2-27. Normally gaining commanders task-organize forces by designating OPCON, attached, or support relationships to another unit or headquarters. Attached units in these brigades are task-organized between brigades as required by the division or higher headquarters commander. When required by tactical circumstance, higher commanders may detach or OPCON units of one brigade to another brigade to reinforce or complement their capabilities. When detaching units from a BCT or combat aviation brigade (CAB), commanders consider the balance of units and capabilities developed in these organizations against the need to adjust their organizations to tactical circumstance. (Note that in contrast to the other brigade types, all BCT and CAB units are organic to the BCT or CAB.)

2-28. Within each brigade, the brigade commander task-organizes all organic, assigned, attached, or OPCON units as required. The commander may choose to use a support relationship (direct support, reinforcing, or general support reinforcing) between units of the BCT or brigade instead of a command rela-



tionship. Figure 2-6 develops figures 2-4 and 2-5 further by illustrating task organization in a hypothetical division, a supporting fires brigade, and the 4th HBCT.

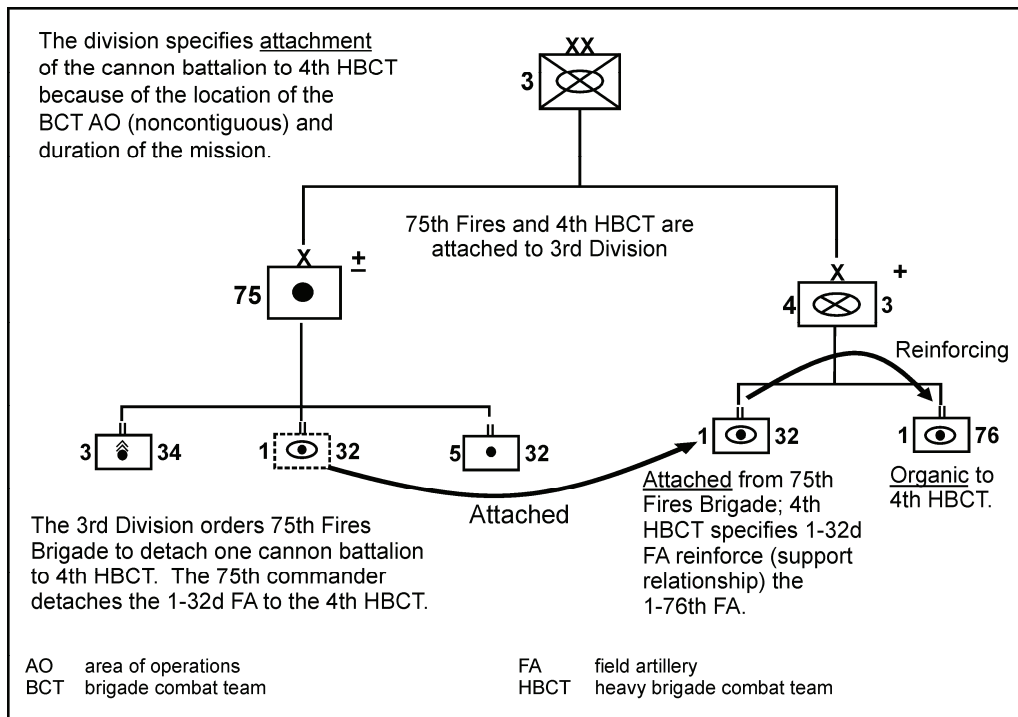

Figure 2-6. Example of task organization in a division

2-29. In Figure 2-6, the 3rd Division commander changes the task organization of forces within the 75th Fires Brigade and 4th HBCT. The division directs the 75th Fires Brigade to detach the 1-32d FA to the 4th BCT. Note that the division attaches the battalion, as opposed to simply assigning, the 1-32d FA the mission of reinforcing the 1-76th FA. Traditionally, the division assigns a reinforcing mission to a FA battalion rather than attaching it. However in this case. The 75th Fires Brigade has been assigned a nontraditional mission and a significant geographical distance divides the 75th Fires Brigade's area of operations (AO) and the 4th HBCT's AO. The BCT commander uses the additional fires battalion to increase the fires capability available across the entire brigade AO by establishing a support relationship (reinforcing) between the organic fires battalion of the BCT (the 1-76th FA) and the attached 1-32d FA.

**This page intentionally left blank.**

## Chapter 3

# Theater Army Organization

This chapter describes the headquarters components and subordinate commands of a theater army. It discusses employment of the theater army headquarters as a joint force land component and joint task force headquarters.

### **ROLE OF THE THEATER ARMY**

3-1. Each theater army is organized, equipped, and trained to command and control land power in support of a geographic combatant commander (GCC). By design, each GCC has an assigned theater army headquarters. The geographic combatant commands consist of United States European Command, United States Pacific Command, United States Central Command, United States Southern Command, and United States Northern Command. The Secretary of Defense previously directed the Army to generate an additional theater army—Eighth U.S. Army for a subunified commander—U.S. Forces Korea. The normal command relationship between the GCC and the theater army is combatant command. Functional combatant commanders—United States Strategic Command, United States Special Operations Command, United States Transportation Command, and United States Joint Forces Command—have their own unique Army Service component commands (ASCCs). These ASCCs are not theater armies.

3-2. A theater army performs two complementary functions for the GCC. First, it is the ASCC and ARFOR headquarters for all Army forces in the theater. In this capacity, the theater army commander—as the ASCC commander—is responsible for administrative control (ADCON) of all Army forces in the supported GCC's area of responsibility (AOR). The term ARFOR includes the senior Army headquarters and all Army forces assigned or attached to a combatant command, subordinate joint force command, joint functional command, or multinational command. An ARFOR commander may not have operational control (OPCON) of all Army forces provided to the joint force commander (JFC); however, the ARFOR commander remains responsible for their ADCON.

3-3. The theater army commander also integrates Army forces into the execution of theater security cooperation plans and provides Army support to joint forces, interagency elements, and multinational forces as directed by the GCC. Figure 3-1 on page 3-2 illustrates the theater army providing ADCON and Army support to other Services (ASOS) to a joint task force (JTF) formed around a corps headquarters with a division headquarters serving as the ARFOR headquarters.

3-4. Second, the theater army with its operational command post (OCP) is also organized and equipped to exercise OPCON of joint and multinational forces in a campaign. It continues to perform its theater responsibilities, with joint and multinational staff augmentation, as appropriate. The OCP provides a base organization around which a JTF or joint force land component (JFLC) headquarters could be organized. Although not organized primarily to act as a JTF headquarters, the theater army headquarters can use its OCP as a base from which to form a JTF headquarters. This headquarters can perform crisis response or conduct limited contingency operations, with augmentation of the standing joint force headquarters (SJFHQ) and other joint Service manning. Within each geographic combatant command, these capabilities increase or decrease through strategic tailoring of the Army forces assigned to that particular theater army headquarters.

3-5. As a JFLC headquarters, the theater army commander exercises OPCON over land forces within the framework of a campaign or major operation. This may include controlling multiple divisions, corps-sized formations, and forces from other Services. Normally during major combat operations, the theater army's OCP provides a base for the JFLC headquarters and responds directly to the GCC. In circumstances where

major combat occurs in two or more joint operations areas (JOAs) simultaneously, the GCC may form a subordinate JTF to conduct major operations, subordinating the JFLC headquarters to the commander of this JTF. However, it is more likely the GCC will employ a corps headquarters in this capacity and keep command of the more serious of the two campaigns.

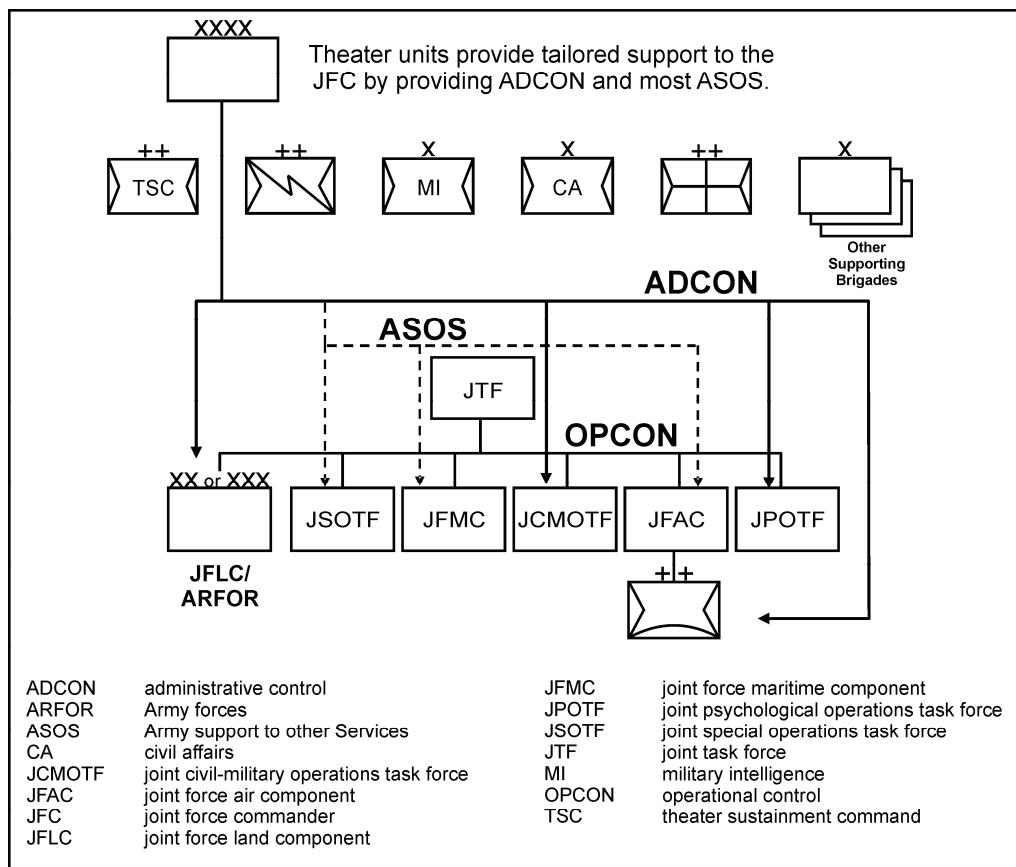

Figure 3-1. The theater army supporting a joint task force

3-6. The theater army generates and supports Army forces in the AOR and supports joint forces as required by the GCC. The theater army—

- Tailors assigned land forces for joint operations.
- Supports theater security cooperation plans with Army forces and appropriate command and control (C2).
- Provides theater-level augmentation to Army forces in JOAs, including ARFOR capabilities, liaison teams, and public affairs teams.
- Develops the directed mission-essential task list for conventional Army forces either assigned to the AOR or programmed to deploy to the AOR as part of an approved Joint Chiefs of Staff operation plan.
- Provides training support, materials, and regional expertise to aligned Army forces.
- Provides ADCON support to all Army forces (to include Army special operations forces) deployed in a theater.
- Provides operational command and control capabilities.
- Provides Army support to the joint force as a whole, the other Services, other U.S. government agencies, and multinational forces as directed.

- Establishes and secures theater bases and conducts reception, staging, onward movement, and integration through the theater sustainment command (TSC) and gaining maneuver units.
- Orchestrates the deployment sequence and introduction of Army forces into theater.

## **THE THEATER ARMY HEADQUARTERS**

3-7. The theater army headquarters structure of two command posts provides its commander with maximum flexibility to meet the requirements to serve as both a Title 10 provider and as an operational commander. The theater army's main command post (CP) provides its commander with continuous theater-wide command and control of ADCON and ASOS functions. The theater army's deployable command post—the OCP—has an embedded early entry capability and provides the commander with a capability to command and control the operations of subordinate operational-level forces. The theater army commander and chief of staff determine the specific manning and organization of each command post. The general capabilities and functions of the command posts are described below.

3-8. The Department of Defense and the GCC tailor the forces assigned to the theater army to meet the GCC's needs. The structure of the theater army headquarters provides the necessary flexibility to adapt its C2 system to meet requirements as they develop. Normally the theater army main CP controls AOR-wide sustainment, medical, signal (network operations [NETOPS]), intelligence, and civil affairs capabilities although the type and size of these capabilities vary considerably between GCCs. These subordinate elements range in size from a brigade to a full command, depending on theater requirements. They provide the theater army commander with the capability to provide ADCON to all Army forces in the AOR. Figure 1-1 on page 1-6 illustrates a typical theater army with its functional headquarters, an array of six regionally focused theater units, and a mix of forces assigned or attached as required by ongoing operations. During the conduct of major operations the theater army may also be assigned additional theater-level commands or functional brigades, such as a theater engineer command or a military police internment and resettlement brigade.

## **THEATER ARMY MAIN COMMAND POST OVERVIEW**

3-9. The main CP is where the commander, the deputy commanding generals, and the commander's personal and the coordinating staff principles, under the supervision of the chief of staff are documented on the table of organization and equipment (TOE). The main CP provides ADCON support to its assigned Army forces in the AOR of a supported GCC. This support includes policy, plans, programs, and budgeting. All Army personnel assigned to the theater army headquarters are organized into the main CP and further assigned to the theater army's headquarters and headquarters company (HHC) for personnel accountability. The main CP with its associated HHC is an Army management headquarters reportable under DODD 5100.73.

3-10. The main CP is the organization responsible for Army activities throughout the supported GCC's AOR. It focuses on—

- Developing and issuing Army AOR-wide policies and providing policy guidance.
- Reviewing and evaluating the performance of Army programs across the AOR.
- Allocating and distributing Army resources throughout the AOR.
- Conducting AOR-wide mid- and long-range planning, programming, and budgeting.

3-11. Three broad design concepts underlie the organization of the modular theater army headquarters:

- First, each theater army headquarters is a regionally focused, globally networked organization. It is not a "pooled" headquarters. The main CP never deploys to another AOR.
- Second, the concept for the modular Army recognizes that requirements of major operations may exceed the resources found in the modular theater army headquarters base TOE. However, the modular design of the theater army headquarters and the theater base provides a flexible platform for Army and joint augmentation in the event of sustained intensive operations.
- Third, the theater army headquarters provides ADCON over all Army forces assigned, attached, or OPCON to the supported GCC while ensuring GCC-directed Army support to joint, inter-

agency, and multinational elements. Both requirements are continuously met by the theater army, regardless of whether it also controls land forces conducting major operations. This is done using the main CP. The main CP enables Army forces to integrate into the execution of regional security cooperation plans and provides Army support to joint forces, interagency elements, and multinational forces, as directed by the GCC.

3-12. The main CP functions to provide continuous oversight and control of operations throughout the supported GCC's AOR. This requires it to have full connectivity with joint information systems. Figure 3-2 depicts the six functional directorates that comprise the organizational structure of the theater army's main CP. The staff at the main CP focuses on planning and executing the theater army's responsibilities, including ADCON of ARFOR in the AOR, and support to joint, interagency, and multinational elements as required by the GCC. The main CP staff directorates develop operational and theater support plans for the theater army, to include developing force-tailoring recommendations. The main CP has a variable number of regionally focused liaison detachments or teams attached that deploy as required to interagency and multinational headquarters. The exact number of teams depends on joint plans and requirements.

3-13. The main CP operates from a fixed location, normally its home station or garrison location. The commander may deploy the main CP to a forward location in the AOR for protracted operations, or may elect to reinforce the OCP with personnel from the main CP on a mission or rotational basis. Regardless of its location, the main CP wholly depends on external support for field housing and other services, electronics maintenance, transportation, communications, and security. It receives its vehicle maintenance, limited medical, and food service support from its associated HHC.

3-14. The current operations integrating center in the main CP has a limited capability to supervise Army current operations throughout the AOR. This operations center directly controls small Army elements scattered throughout the supported GCC's AOR. These elements are primarily involved in theater security cooperation activities and small-scale operations.

## **THEATER ARMY OPERATIONAL COMMAND POST OVERVIEW**

3-15. The OCP is a theater-level organization that provides a C2 facility for the theater army commander, or another designated individual, when the commander acts as an ARFOR, JFLC commander, or joint force commander within a JOA. Figure 3-3 on page 3-6 depicts the organization of the OCP. It normally deploys into a JOA in two echelons. The first echelon is the early entry command post (EECP). The second echelon falls in on the EECP and absorbs the EECP into the structure of the OCP. The theater army commander relies on the OCP to provide the initial command and control system capability. Such capability allows commanders to direct those forces assigned, attached, or under their OPCON. The capabilities of the OCP staff may require additional augmentation to meet the demands associated with the conduct of major operations since its design provides minimal essential capabilities. For example, a rear operations center may be employed to augment the theater army staff if the theater army commander is designated as the joint security coordinator or if required by the factors of METT-TC. The OCP's personnel and equipment are deployable by fixed-wing aircraft from their garrison location into a JOA. However, the OCP has limited mobility in organic vehicles once deployed into the JOA and typically occupies semipermanent fixed facilities.

3-16. The EECP is a component of the OCP. It includes small sections from each functional element of the OCP staff that enable the EECP to C2 expeditionary operations for up to 14 days. (See figure 3-4 on page 3-7.) Therefore, the EECP is designed to be 100 percent mobile in organic vehicles and deployable on C-17 aircraft. The theater army commander deploys the EECP under the direction of one of the two deputy commanding generals. Primarily the EECP deploys into the JOA by air and becomes the OCP's forward element during the initial stages of the operation. Because the OCP may be forward stationed while corps and division headquarters are not, the EECP deployment may precede deployment of a corps or division C2 structure for a small-scale contingency. The EECP can redeploy once an alternative C2 structure is in place, such as the deployable command post of the TSC or a corps or division headquarters.

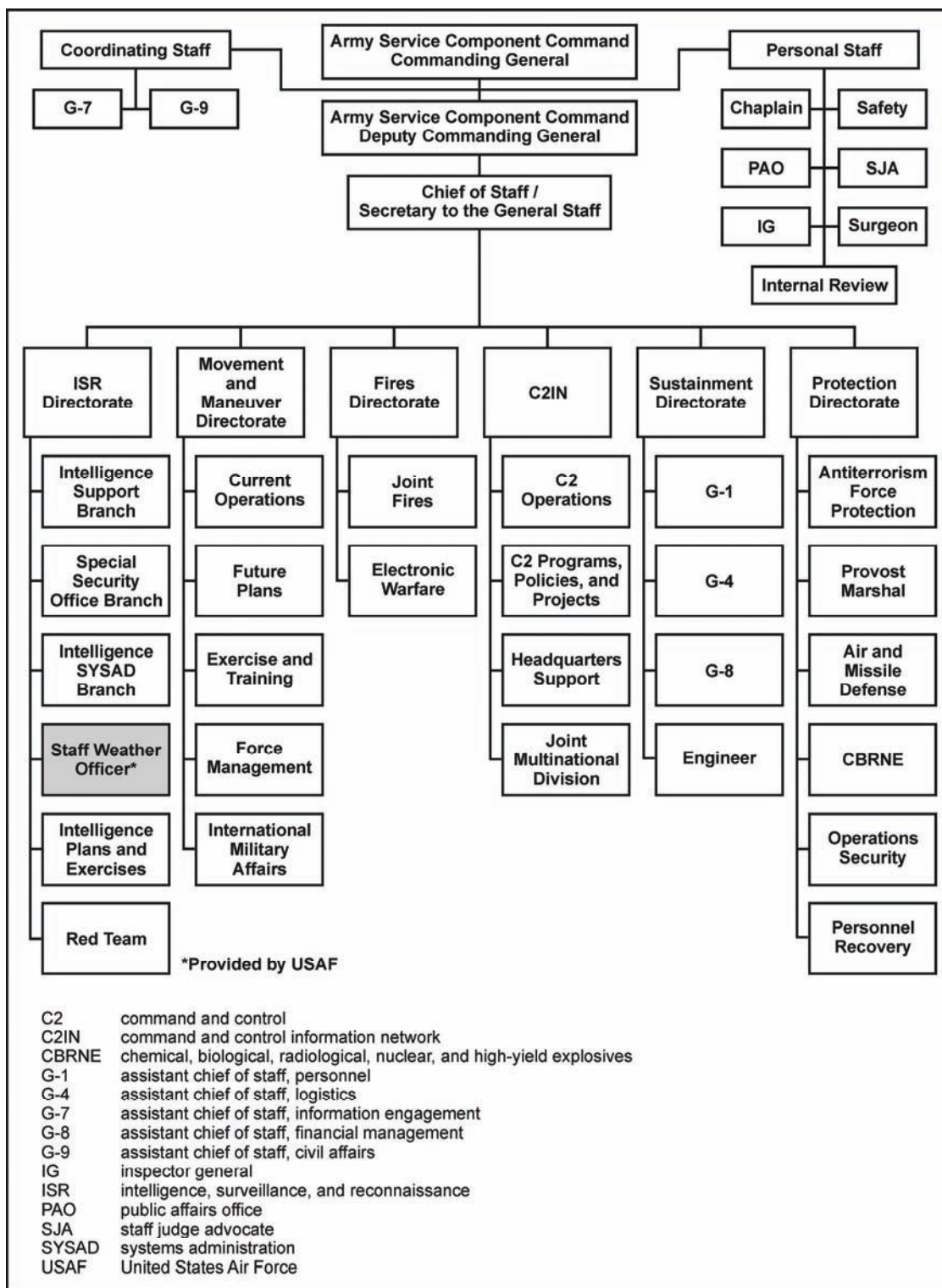
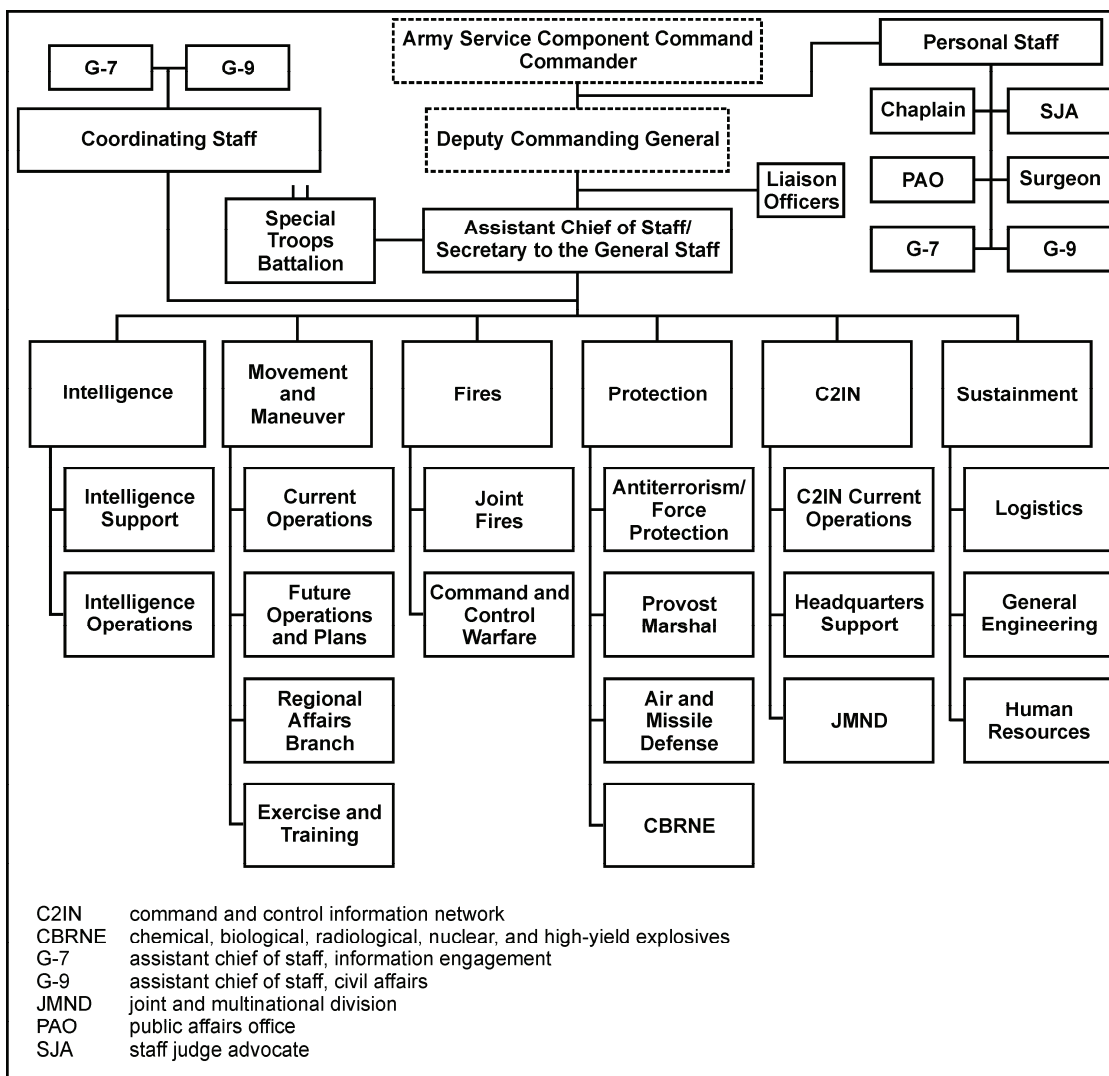

Figure 3-2. Theater army headquarters and main command post

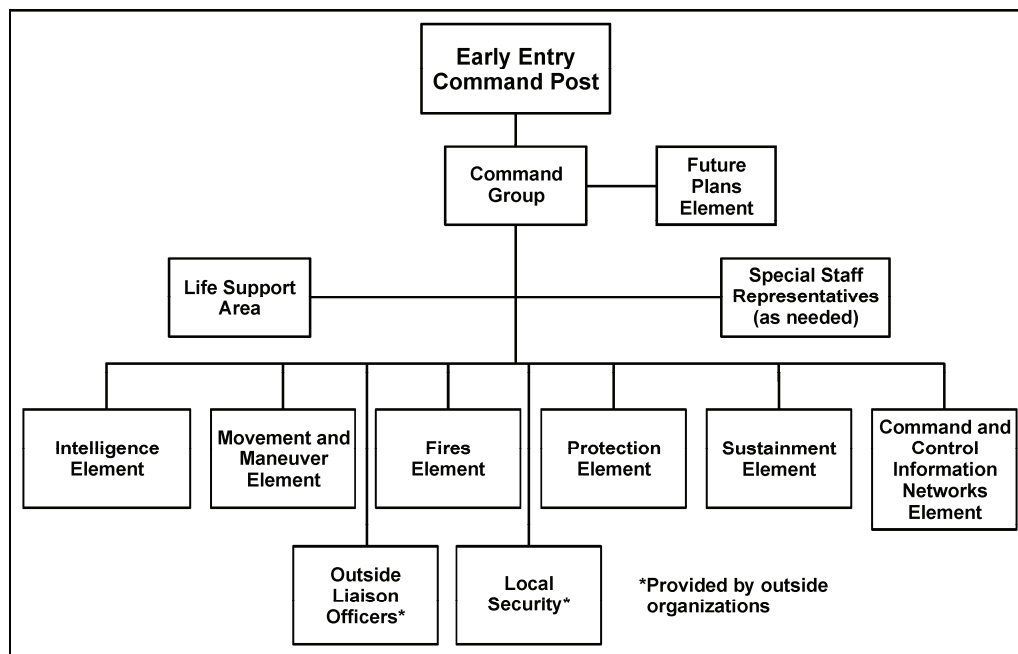

**Figure 3-3. Operational command post**

3-17. The EECP enables the theater army commander to project a small, easily transportable by air, deployable operations center into an area of operations (AO). This EECP has limited capabilities and is not resourced for extended operations. It provides an austere, but functional, capability from initial entry to the arrival of the rest of the OCP from its previous location. It consists of seven cells and other capabilities provided as necessary by the factors of METT-TC. EECP personnel possess a wide range of skills and each individual trains to be multifunctional staff officers outside the competency of their basic branch or specialty. The OCP TOE designates those individual positions normally constituting these cells.

3-18. The EECP provides the theater army commander with inter- and intratheater links to the GCC, subordinate JFCs, and other components. It can deploy simultaneously with the initial brigade combat teams (BCTs) entering the AO based on the factors of METT-TC. Most policy decisions are accomplished in the ASCC main CP which may or may not be located in the AO. Many ARFOR and JFLC planning, preparation, execution, and assessment decisions are accomplished in the OCP, which may or may not yet be located in the supported JFC's JOA. The personnel and equipment in the EECP are reintegrated into their related staff section when the OCP completes its deployment into the JOA.





**Figure 3-4. Early entry command post**

3-19. The factors of METT-TC will determine the exact composition of each cell of the deployed EECP and the exact functions that they will perform. For example, in a situation where the mission largely focuses on stability operations, an EECP may require heavy G-2X representation since HUMINT tends to be more important when operations are stability focused versus a focus on offensive operations. It also may need to have more civil affairs, comptroller, and engineer representation than indicated on the OCP TOE. As always, the theater army commander has the ability to task-organize available theater assets. Because each commander has a unique command style, all theater army C2 nodes are tailored to best fit that style.

### THEATER ARMY HEADQUARTERS BATTALION OVERVIEW

3-20. The theater army headquarters battalion consists of the battalion headquarters and the OCP's headquarters company. (See figure 3-5 on page 3-8.) Together the main command post HHC and OCP headquarters company provide necessary basic support capabilities. The basic support capabilities include mess, medical, and ground vehicle maintenance. They provide these life support services to the main command post and OCP and small units, teams, and detachments supporting the command post such as the OCP's supporting signal company from an integrated theater signal battalion. The headquarters battalion commander will be the base commander for the base formed by the OCP and its supporting elements. The headquarters battalion staff is responsible for manning and running the base operations center. The priority of support for the headquarters battalion is to any forward deployed command post. This may be the EECP when it is deployed separately, but normally it is the OCP.

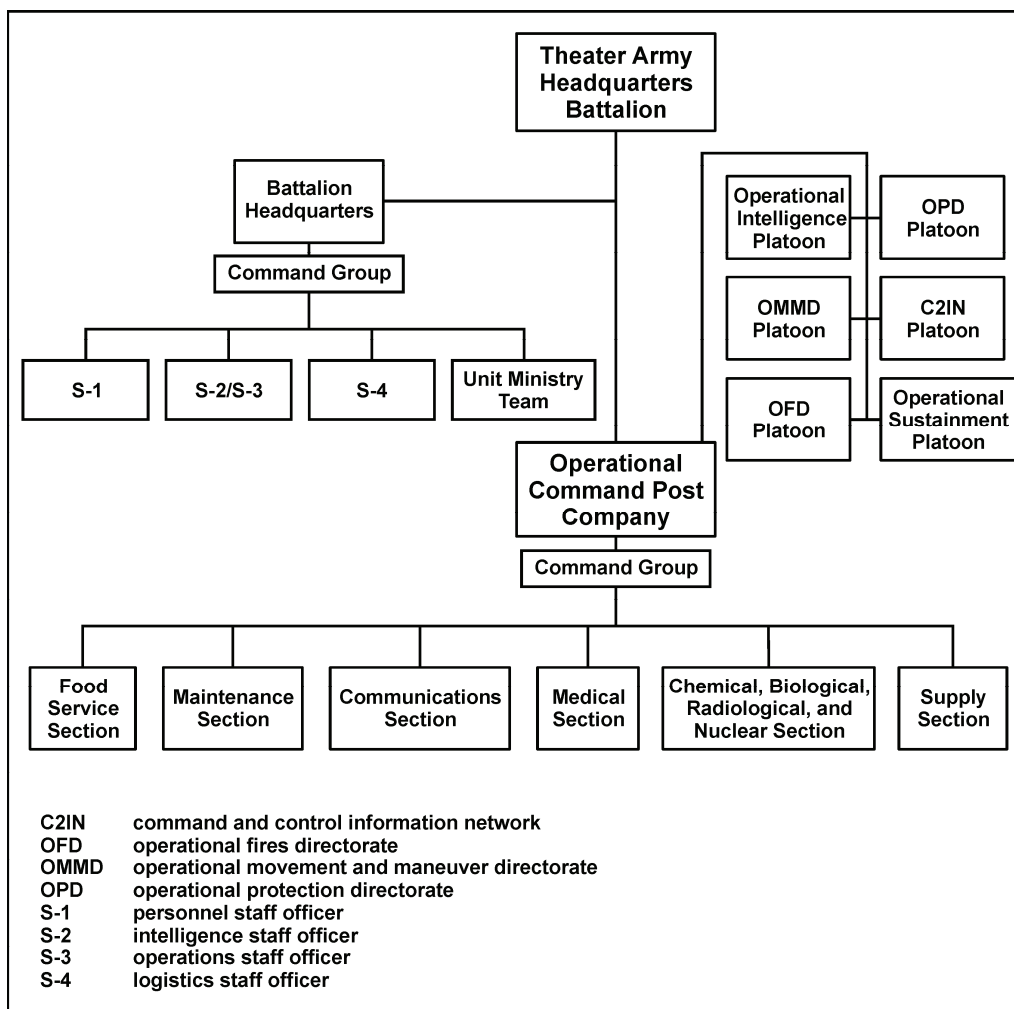

Figure 3-5. Operational command post headquarters battalion

## SUBORDINATE COMMANDS OF A THEATER ARMY

3-21. As the Army headquarters supporting the GCC, the theater army provides various combinations of Army capabilities and orchestrates their employment. The theater army provides ADCON of all Army personnel, units, and facilities in the AOR and provides ASOS and common-user logistics (CUL) as directed by law or the GCC. Some contingencies may require the deployment of significant Army capabilities in these same areas either before or without the deployment of tactical Army forces. To accomplish these tasks, the theater army controls an assigned mix of regionally focused, supporting commands and brigades, including sustainment, signal, intelligence, and civil affairs, and medical as shown in figure 1-1 on page 1-6. In addition to these regionally focused commands, the theater army receives additional attachments in the form of brigades and commands requisite for the campaign or missions in the AOR. These latter forces are not regionally focused but drawn from the pool of available forces assigned to general warfighting and maintained in the continental United States (CONUS) and around the world. The theater situation dictates the size of these formations, that is, commands, brigades, or groups. Command relationships also vary across theaters between the theater army and supporting capabilities. In some theaters, the commands are assigned, in others, OPCON or aligned for planning only. (The United States Army, Northern Command/5th Army structure significantly differs from the structure of other theater armies. It has a mix of le-

gal restrictions and not all CONUS-based Army commands and direct reporting units are available to perform the specialized functions of the theater army's normal subordinate commands.)

3-22. These regionally focused supporting commands and brigades normally include a theater sustainment command, a theater signal command, a military intelligence brigade, a civil affairs brigade, and a medical deployment support command. This publication discusses these subordinate elements in terms of commands and brigades. However, their actual size and designation will be adjusted to the demands of that theater army commander and theater responsibilities. Each subordinate command can support Army forces in a JOA through modular C2 provided to the division and support accomplished by the forces OPCON to them. This discussion uses the largest sized formations habitually associated with a particular theater army.

### THEATER SUSTAINMENT COMMAND

3-23. The TSC is the senior Army sustainment headquarters in an AOR. (See figure 3-6.) (While its focus is on sustainment, it does not provide the health service support component of sustainment, which is done by the medical command (deployment support).) In response to the modular redesign of the Army, it changes the way to accomplish the sustainment warfighting function in an AOR by establishing a single sustainment C2 authority in an AOR. Reducing the support echelons previously resident in the theater, corps, and division support commands, the TSC provides the modular Army with a single operational echelon. This echelon is responsible for C2 of sustainment operations in support of Army as well as joint, interagency, and multinational forces. The modular force design provides the TSC commander with the flexibility to adapt command and control and deploy the expeditionary sustainment command (ESC) command post forward in an AOR. This deployment provides the additional measure of responsiveness, agility, and flexibility for employment or deterrence.

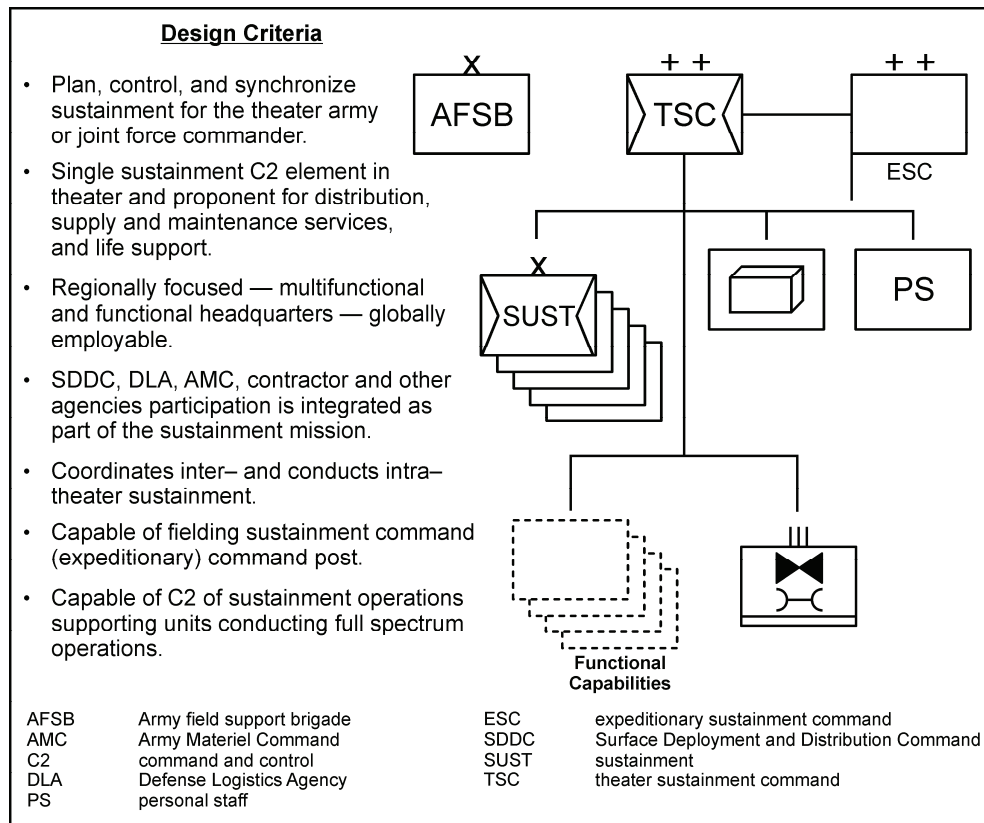

Figure 3-6. Example of theater sustainment command

3-24. The TSC includes a standardized headquarters organization with modular subordinate units capable of providing multifunctional sustainment to include supply, maintenance, transportation, petroleum, and port and terminal operations. Other specialized capabilities are available from the force pool. Such capabilities can include mortuary affairs, theater aviation supply and maintenance groups, financial management, and human resources. The combination of these capabilities enables the TSC commander to organize and provide tailored sustainment functions— theater opening, distribution, or support to theater forces.

3-25. The mission of the TSC is to deploy rapidly so to plan, prepare, execute, and assess operational sustainment in an assigned AO or JOA. The TSC is capable of planning, and executing all sustainment operations for the theater army or JFC. It provides single sustainment command and control in theater and support of operations during simultaneous deployment, employment, sustainment, redeployment, and reconstitution. It is regionally focused. Its subordinate ESC command post is globally employable and capable of operating as part of joint and multinational forces. The ESC command post allows the TSC to provide tailored command and control to small-scale contingencies in separate JOAs or AOs that do not require the TSC headquarters full capabilities. Each ESC is capable of providing support to Army, joint, interagency, and multinational forces. Inherent to TSC success is its ability to leverage joint and strategic partners, such as the United States Transportation Command (USTRANSCOM), Defense Logistics Agency, and General Services Administration; and synchronize their support.

3-26. The TSC commander serves as the senior Army sustainment commander for the theater army. The TSC provides command and control of assigned, attached, and OPCON units executing theater opening, theater distribution—including aerial delivery and air drop, supply, maintenance, field services, contracting, contract management, procurement, transportation, human resources, and financial management. The TSC will maximize throughput of Army forces and other supported elements. Specialized elements, such as the Human Resources Sustainment Center and Financial Management Center maintain their national-level technical linkages and continue to receive staff guidance from the theater army G-1 and G-8 staff, respectively. There will also be an Army field support brigade (AFSB) OPCON to each TSC. These AFSBs maintain national-level support links to the Army Materiel Command's Army Sustainment Command as well as to the Assistant Secretary of the Army Acquisition, Logistics, and Technology; program managers, and program executive offices. It will provide support to the operational-level units in the theater army AO and overall support to Army forces. The TSC will also execute those lead Service CUL support requirements assigned by the theater army.

3-27. The TSC rapidly establishes command and control of operational-level logistics in a specified AO or JOA by using its ESC command posts. Each ESC command post provides a rapidly deployable, regionally focused forward-based sustainment command and control capability that mirrors the TSC organization and functionality. It normally deploys to an AO and represents the senior sustainment command in the AO—until or unless the TSC deploys. The TSC commander relies on the ESC to direct TSC forces in that AO. The ESC can also be employed in an AO to expand the TSC's span of control.

3-28. By design, the ESC command post executes the full gamut of sustainment operations. However, ESC command post operations are limited in scale and scope. They employ reach capabilities to provide the full range of support, and conduct sustainment operations according to TSC plans, policies, programs, and mission guidance. The ESC command post lacks the planning and materiel management capabilities found in the TSC headquarters.

3-29. As the proponent for distribution in a theater of operations, the TSC leverages Army generating force and joint capabilities to establish an integrated theater-level distribution system that responds to JFC requirements. The TSC employs multifunctional sustainment brigades to execute theater opening and distribution operations. These operations are synchronized with the JFC campaign plan and intent. It also provides command and control of sustainment brigades supporting distributed operations along multiple lines of operations.

3-30. Satellite-based communications and redundant networked battlefield communications provide visibility of the distribution system, enabling the TSC to receive data from the strategic, operational, and tactical levels. This capability provides the TSC with information and the means to synchronize multinodal,

multimodal distribution operations with the JFC campaign plan, intent, and operational tempo based on timely, accurate, and relevant sustainment information.

## SIGNAL COMMAND (THEATER)

3-31. Theater signal forces have undergone their own transformation in support of the modular force. The transformation of the Army to a BCT-centric construct with embedded signal capability resulted in the inactivation of division signal battalions and corps signal brigades. This left over 45 percent of Army forces dependent on theater signal organizations for pooled network support. The blurring of traditional echelons inherent in Army transformation drove a requirement for operating the Army's network from an enterprise perspective, which requires world-wide common signal tactics, techniques, and procedures and technical standards. The following theater signal forces are assigned to U.S. Army Network Command (NETCOM)/9th Signal Command (Army) and attached to the theater army as required—

- Signal command (theater).
- Theater network capability module (TNC-M).
- Signal center (theater).
- Signal brigade (tactical).
- Signal brigade (operational base).
- Signal battalion (operational base).
- Signal detachment (operational base).
- Expeditionary signal battalion.
- Combat camera company.
- Tactical installation and networking company.

3-32. In a major combat operation (MCO) theater, the signal command (theater) (SC[T]) is the senior operational signal organization in theater. In a non-MCO theater the senior operational signal organization is the signal brigade (tactical), which is augmented with a TNC-M. The SC(T)s and the tactical signal brigades are under the combatant command of their supported GCC, with operational command exercised through the respective theater army. The two existing SC(T)s are Reserve Component headquarters. The SC(T)s and the tactical signal brigades receive technical command, control, communications, and computer operations (C4OPS) and information technology direction via technical channels from NETCOM/9th Signal Command (Army), the applicable GCC J-6, and United States Strategic Command (USSTRATCOM)/JTF-Global Network Operations to ensure global enterprise management, technical compliance, and network defense. Within their respective theaters, the senior signal commander of each SC(T) or tactical signal brigades is dual-hatted as the theater army G-6. This dual-hat relationship ensures a single focal point for planning, execution, and synchronization of enterprise C4OPS and information technology operations, which includes NETOPS and allocation of pooled signal support.

3-33. The SC(T) design represents a significant shift from the previous theater signal command design. Theater communications security and frequency management has migrated from the SC(T) to the theater army staff. Additionally, the SC(T) now performs all network operations functions. Conversely, the SC(T) now has a significant planning and engineering capability in support of both the operational base and tactical networks. The SC(T) has the mission to execute command, control, and supervision for assigned and attached units to provide network operations in support of Army, joint, interagency, and multinational operations. The SC(T) will oversee theater communications operations to leverage the LandWarNet enabling extension and reachback capabilities. The SC(T) will accomplish this by planning, engineering, operating, maintaining, and defending network systems installed by theater signal units. Additionally, the SC(T) integrates network systems installed by other units to include joint, interagency, and multinational organizations. Based on the theater's factors of METT-TC, the SC(T) leverages and exercises C2 over subordinate signal organizations to accomplish its mission, which could include two or more theater signal brigades. (Figure 3-7 on page 3-12 provides a notional MCO theater signal structure.) The SC(T) also relies on other organizations for large-scale communications infrastructure architecture support; theater facility engineering support; health services; personnel, finance, and administrative services; troop transportation support; and legal services.

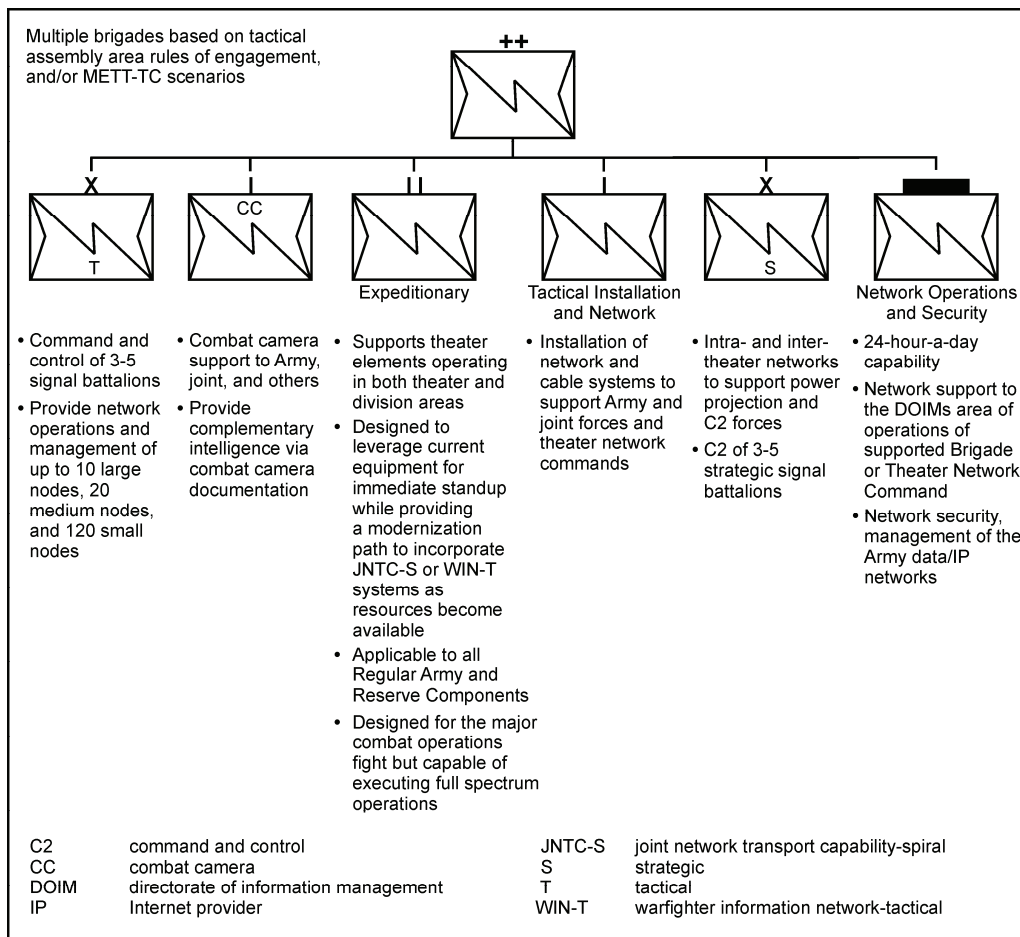

**Figure 3-7. Signal command (theater) example of subordinate elements**

3-34. The Army Campaign Plan, specifically decision points 35 and 36, directed the stand-up of a downsized SC(T) capability in AORs where MCO capabilities were not resourced. The TNC-M provides this capability. In those AORs assigned a tactical signal brigade as the senior signal organization, a TNC-M augments the signal brigade. The TNC-M provides an enterprise operations and C2 support capability to meet the GCC's daily operational requirements. The TNC-M augments the tactical signal brigade with theater-level network planning, engineering, architecture development and integration, and training support. The TNC-M also provides the senior staff for personnel, intelligence, and logistics, which is the primary interface to the theater army staff. When the tactical signal brigade deploys, the TNC-M executes these functions and performs C2 of assigned theater signal operational base (strategic) and tactical forces. The TNC-M will have an augmentation Table of Distribution and Allowances based on the factors of METT-TC.

3-35. The tactical signal brigade provides similar but downsized services as that provided by the SC(T). A tactical signal brigade provides C2 of from two-to-five theater signal battalions, supporting signal companies, and other assigned or attached signal forces. The tactical signal brigade is under OPCON of a SC(T) in those AORs conducting or projected to conduct major combat operations. In all other AORs the tactical signal brigade is the senior signal element. In addition to C2 of subordinate signal forces, the tactical signal brigade provides detailed network architecture planning and engineering. This brigade oversees the installation, operation, and maintenance of communications networks in support of high-level plans developed

by the theater army G-6. All tactical signal brigades are ADCON to NETCOM. They either support a GCC or are part of the force pool in support of the Army force generation (ARFORGEN).

3-36. Efforts are underway to re-designate all strategic signal forces as operational base signal forces. Capabilities provided by these operational base signal forces encompass regionally-located, fixed-station satellite terminals and microwave sites; subscriber network services; and network operations support. Additionally, operational base signal forces are tasked with many high-visibility missions such as nuclear C2 support, secret service communications, operations and maintenance of the Army's Defense Red Switch Network, and the Presidential direct communications link.

3-37. The operational base signal forces are equally critical to the ARFORGEN process. Working closely with commercial telecommunications companies in CONUS and in forward deployed locations, they deliver C2 capabilities throughout all phases of the ARFORGEN cycle, leveraging joint and national assets, and enabling end-to-end seamless communications.

3-38. The operational base signal brigade provides C2 over subordinate battalions, companies, and other assigned signal forces and network planning and engineering for the operational base. Collectively, the operational base signal forces are the center of gravity for the LandWarNet. These forces provide the backbone of the Army's portion of the Global Information Grid, continuously extending robust, secure network capabilities to the theater strategic and operational commanders as well as power projection, training, and support platforms. The operational base signal forces provide C4OPS capabilities designed to be available seamlessly throughout all phases of operations.

3-39. The theater network operations and security center provides and oversees network operations services for supported elements within its AO. This center facilitates end-to-end efficiency of the LandWarNet and the Global Information Grid; provides continuous LandWarNet and Global Information Grid situational awareness and understanding as it relates to mission, operational, and technical impacts in support of GCC operational requirements. This center also supports all phases of full spectrum operations consistent with joint and Army network operations concepts of operations.

3-40. An expeditionary signal battalion uses a highly multifunctional design that plans, engineers, installs, operates, maintains, and defends a minimum of 30 command, control, communications, computers, and information technology nodes. This design supports combatant command, theater Army, JTF, and JFLC commanders. The expeditionary signal battalion assumes missions previously conducted by theater and corps signal organizations. Additionally, it supports theater-level functional brigades and subordinate battalions regardless of their location in a JOA. Other capabilities of the expeditionary signal battalion include the following:

- Provide NETOPS support to battalion and larger deployed theater units.
- Operate continuously in austere environments to provide voice and data capabilities to commanders to include providing services that enable customers to use the LandWarNet and gain access to joint systems.
- Operate and manage the underlying transport networks to provide LandWarNet applications and services.
- Extends transport layer of the network across all echelons.
- Maintain situational awareness of all NETOPS functions of subordinate and higher elements within the AOR.
- Operate within the theater-level NETOPS configuration management program to include integrating the supported unit's NETOPS with those of theater forces supporting the unit's operations.
- Perform defense communications system restoration.

3-41. The tactical installation and networking company deploys worldwide to provide semipermanent network installation using a user-provided bill of materiel. This company performs quality assurance testing and handoff coordination to enable transition from tactical to semipermanent automation support on installation completion. It provides the following services in support of ARFOR, GCC, NETCOM/9th Signal Command (Army), JTF, and multinational force commanders:

- Technical expertise to interpret and implement engineer implementation plans for communications systems.
- Installation, maintenance, and repair of aerial, buried, or underground cable, wire, and fiber-optic transmission systems.
- Repair and maintenance of indigenous cable, wire, and fiber-optic systems.
- Connect various theater headquarter local area networks into required wide-area network via cabling, hardware installation, and connection to tactical and indigenous switches and transport systems.
- Antenna and tower construction and repair.
- Digital system installation to include network security hardware, SIPRNET (SECRET Internet Protocol Router Network), NIPRNET (Non-Secure Internet Protocol Router Network), and video teleconferencing.
- Installation or restoration of a strategic to tactical interface path.
- Quality assurance testing and handoff of installed and restored systems.

3-42. The combat camera (COMCAM) company mission is to provide digital and analog motion and still visual documentation covering armed forces in war, natural disasters, and training activities. Such documentation is an essential battlefield information resource that supports strategic, operational, and tactical mission objectives. COMCAM products provide fundamental tools for commanders and decision makers that when properly used is an effective combat multiplier. Sharing COMCAM documentation, as required, simultaneously supports the operational and planning requirements of commanders and decision makers. The theater operational commander determines collection requirements based on local mission objectives and is the releasing authority for all COMCAM imagery. COMCAM assets are attached to the senior signal organization in theater and under the OPCON of the Army operational commander.

### MILITARY INTELLIGENCE BRIGADE

3-43. Military intelligence brigades (MIBs) support the theater army, other Army operational-level commands in the AOR, and combatant, joint, or multinational commands. These headquarters are under ADCON of U.S. Army Intelligence and Security Command and are OPCON to the theater armies. The following battalions are in the brigade: the operations battalion, the forward collection battalion (counterintelligence and human intelligence) and the forward collection battalion (signals intelligence). The U.S. Army Reserve (USAR) theater support battalion is assigned to the Military Intelligence Readiness Command and under OPCON to the MIB. The strategic signals intelligence battalion and the military intelligence battalion (interrogation) are attached for administrative control to the MIB headquarters. Limited MIBs will have a military intelligence battalion (interrogation) subordinate to them. (See figure 3-8.)

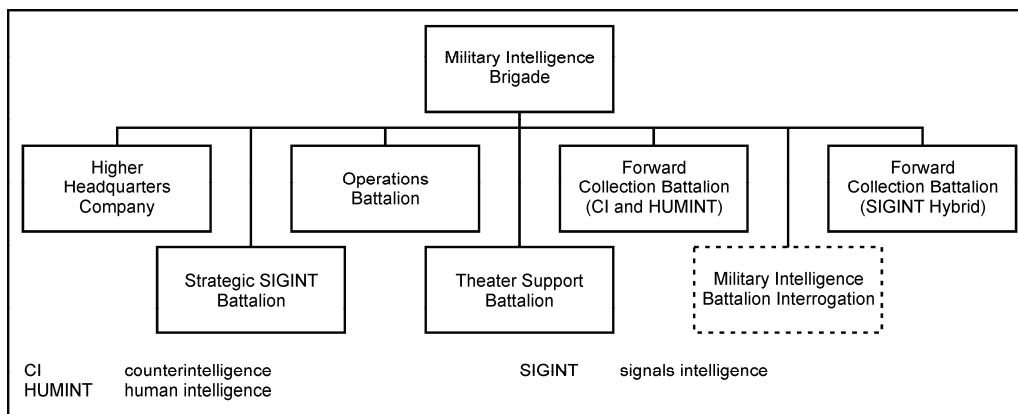

Figure 3-8. Example military intelligence brigade



3-44. These headquarters conduct intelligence operations, all-source intelligence analysis, production, collection management, and dissemination in support of the theater army. Continuous theater security cooperation plans and small-scale contingencies require them to perform two missions. First, on a day-to-day basis through the theater army, they provide dedicated long-term, continuous support to the GCC or sub-unified commander during the conduct of that commander's theater security cooperation plan and small-scale contingencies. Second, they provide in-theater intelligence support during major combat operations.

3-45. The MIB contains only the minimum scalable organizations specifically designed and structured to support the theater army's security cooperation activities and small-scale contingencies in the AOR or a JOA during normal operations. This reduces the forward footprint of the MIB while allowing it to remain responsive to GCC needs. Their multicomponent composition—Regular Army, Army National Guard, and USAR—provides manpower efficiencies. For theater-level functions, other Services may augment the MIB.

3-46. The MIB provides the theater army commander dedicated intelligence capabilities for all intelligence disciplines. Each theater has dedicated signals intelligence operations capabilities, to include signals intelligence collection and analysis. They have robust counterintelligence and human intelligence capabilities with counterintelligence, interrogation, and exploitation potential. These capabilities are multicomponent across the MIBs. Additionally, each brigade has dedicated imagery intelligence analysts, and most have imagery intelligence collection capability. They also have measurement and signature intelligence capabilities.

3-47. The MIB can be expanded by Regular Army and Reserve Component augmentation and deployed as more robust organizations in support of a theater army during major combat operations. The MIB is tailored to meet theater army intelligence requirement and is the foundation for ARFOR intelligence support during major combat operations. It serves as a C2 headquarters for assigned, attached, or OPCON military intelligence elements. Each MIB is designed specifically to support the AOR in which it operates. This regional tailoring ensures the appropriate mix of organizations, intelligence equipment, linguists, area expertise, and databases to meet the commander's requirements. The MIB can operate in a split-based configuration during force projection operations.

## **CIVIL AFFAIRS COMMAND AND BRIGADE**

3-48. Each theater army with the exception of United States Army, Northern Command/5th Army has a theater-focused civil affairs command (CACOM) aligned with it. The CACOM develops the civil affairs-related portion of plans, policies, and programs for both the GCC and the theater army commander. The CACOM uses planning teams, fusion of information management, engagement, and analysis at the strategic- and theater-level. Its primary mission is to provide theater-level civil affairs planning, coordination, policies, and programs in support of stability operations. The CACOM may deploy a theater-level civil affairs operations center to coordinate, analyze, and enable policies, programs, and stability operations capabilities in support of the theater army. When the CACOM deploys, it receives ADCON support from the theater army. The CACOM is the only civil affairs organization that has specialists in all six functional areas and fourteen functional specialties. The CACOM normally remains in support of the GCC.

3-49. When the theater army commander is designated as a JTF or a JFLC commander and deploys the OCP, the theater army commander will be supported by a USAR civil affairs brigade. The USAR civil affairs brigade consists of an HHC, a civil affairs operations center with two civil liaison teams, one functional specialty cell, and one or more civil affairs battalions. (See figure 3-9 on page 3-16.) Depending on the operation's scale, the theater army may receive additional civil affairs units for further attachment to major subordinate commands. As a minimum, each subordinate division commander can expect support from at least one civil affairs battalion. The TSC commander may also have a civil affairs battalion in support.

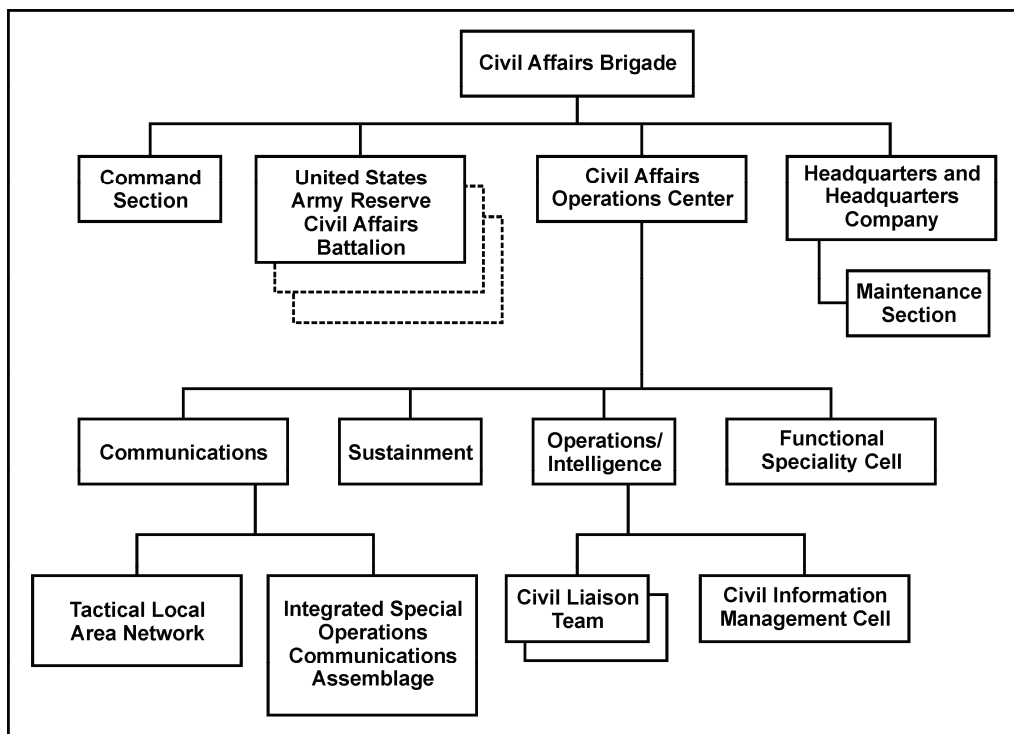
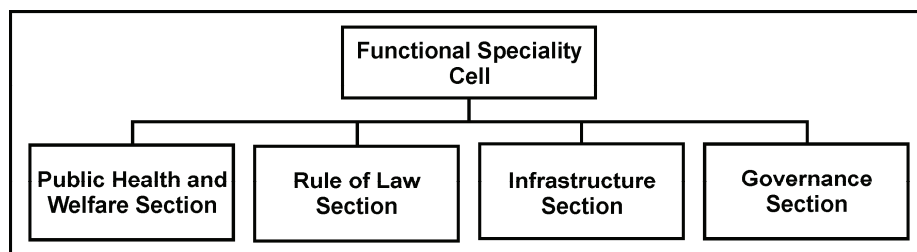

**Figure 3-9. USAR civil affairs brigade operational structure**

3-50. A civil affairs brigade's capabilities include—

- Serving as the JTF or JFLC commander's senior civil affairs adviser (brigade commander).
- Establishing an operational-level civil affairs operations center that is C2 system capable in support of joint, interagency, and multinational operations by various means.
- Serving as a mechanism for civil affairs coordination to produce focused civil inputs to the common operational picture.
- Planning, coordinating, and enabling operational-level stability operations in coordination with the host nation, international organizations, nongovernmental organizations (NGOs), and other government agencies (OGAs) focused on the regional to national levels of civil governments.
- Providing C2 for subordinate civil affairs battalions and companies and other civil affairs capabilities.
- Providing cross-cultural communications, limited linguistic capability to the supported command, advice to the commander on cultural influences in the AOR.
- Providing the capability to establish the core of a joint civil-military operations task force.
- Conducting C2 of select operational-level civil affairs functions and capabilities (forces).
- Providing the ability to assess, develop, obtain resourcing, and manage operational-level humanitarian assistance and stability operations spending implementation strategy. (This function requires a dedicated contracting officer and financial management officer.)
- Providing provincial-to-national level civil liaison team capability.
- Providing the civil-information management cell as the focal point for operational-level collation, fusion, and analysis of civil information; developing operational-level civil inputs to the common operational picture with the brigade civil affairs operations center; and linking civil information to the appropriate military and civil systems via geo-spatially referenced data.

- Providing functional specialty cells able to perform an intermediate-level threat assessment to a civil component of the environment at the subnational level; assessing mission planning requirements; and developing, coordinating, and synchronizing resources to meet the immediate need in four of the six functional specialties: health and welfare, rule of law, infrastructure, and governance. (See figure 3-10.)



**Figure 3-10. USAR civil affairs brigade functional specialty cell**

3-51. A civil affairs brigade may be tasked to support a JTF, JFLC, corps, or Marine expeditionary force (MEF) headquarters. It can provide staff support to other component and joint theater staffs on a mission basis as required. It accomplishes its mission by attaching subordinate elements to supported commands.

3-52. The civil affairs brigade functions as the regionally focused, expeditionary, operational-level civil affairs capability that supports the theater army and its subordinate units. (The CACOM continues to support the GCC.) The USAR civil affairs brigade supports the operational headquarters and possesses a civil affairs functional specialist cell not present within the Regular Army civil affairs brigade. The civil affairs brigade focus is stability operations. The civil affairs brigade enables support to civil administration. It uses the operational C2 system structure to form a coalition joint civil-military operations task force. The brigade headquarters provides command, control, and staff supervision of the operations of the civil affairs brigade and assigned civil affairs battalions or attached units. Its focus is on tactical and operational employment of civil affairs forces and attached civil affairs forces. The civil affairs brigade plans, enables, shapes, and manages civil affairs operations by, with, and through indigenous populations and institutions, intergovernmental organizations, NGOs, and OGAs through its civil liaison team.

### **MEDICAL COMMAND (DEPLOYMENT SUPPORT)**

3-53. The medical command (deployment support) directs all theater Army medical elements. Figure 3-11 on page 3-18 illustrates an example of a medical command (deployment support). When the Army is the lead Service for medical support, it also supports joint and multinational commands and other elements under the guidance of the theater army surgeon. The theater army surgeon provides policy and technical guidance to the medical command (deployment support) and all Army medical units in the theater. The medical command (deployment support) assists the theater army staff surgeon to establish medical policies for the AOR. It also maintains a technical channel with various theater medical support activities. The medical command (deployment support) develops plans, procedures, and programs for medical support in the theater army. This includes patient evacuation, patient care and movement, hospitalization, stress control, preventive medicine services, dental services, veterinary services, and laboratory services. The medical command (deployment support) supports the joint force surgeon's joint patient movement requirements center in accordance with lead Service directives. It provides staff planning, supervision, training, and administrative support of subordinate medical brigades engaged in operational-level medical support. It provides combat health logistics, including medical requirements determination and medical supply control.

3-54. The medical command (deployment support) commands one or more medical brigades. The medical brigades are tailored according to theater requirements and normally attached to the division or other joint forces. The medical command (deployment support) maintains a technical channel with designated medical functions executed by the medical brigades.

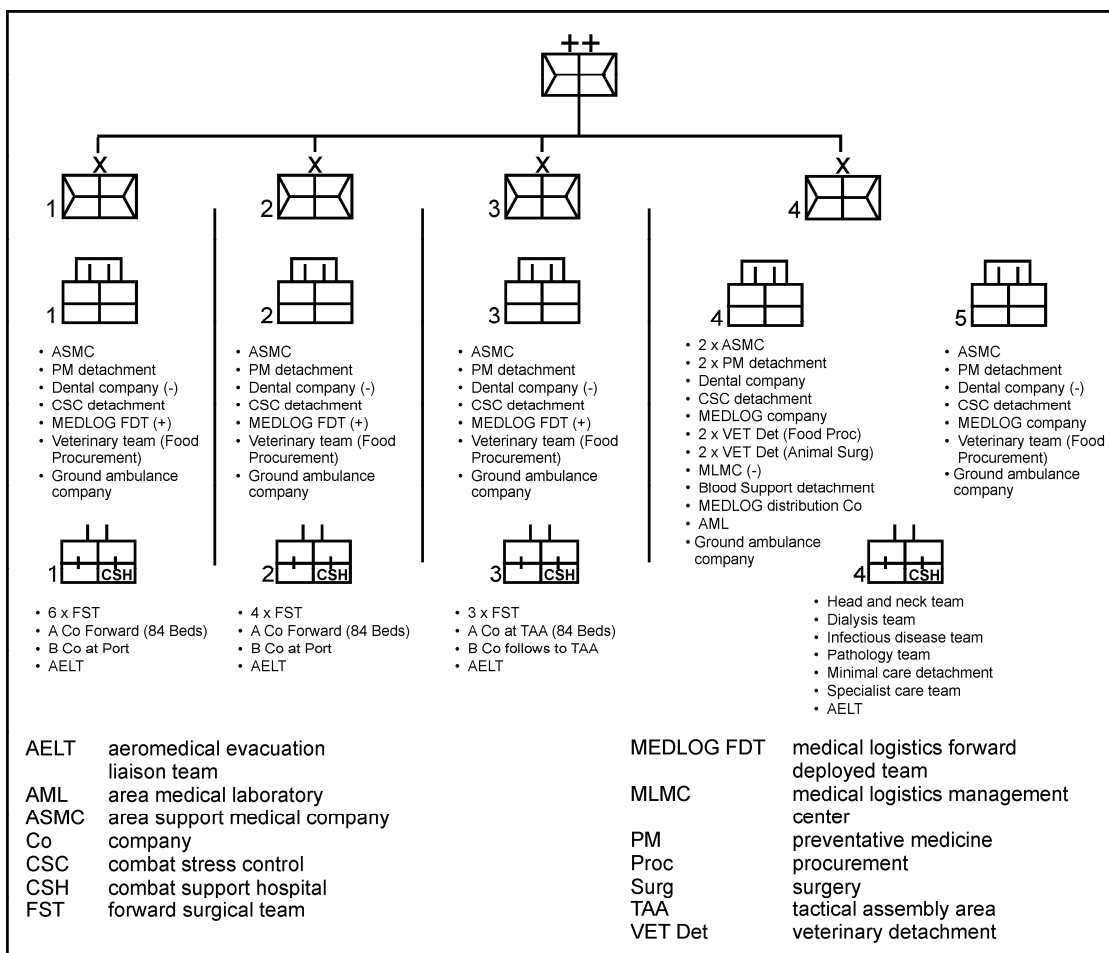

Figure 3-11. Example medical command (deployment support)

### AIR FORCE AIR SUPPORT OPERATIONS CENTER

3-55. While the Air Force air support operations center (ASOC) is the air component commander's center to control coordinate and direct airpower assets. The ASOC provides the following functions:

- Controls close air support assets within the AO of the supported unit.
- Coordinates and directs preplanned and immediate air interdiction requests flown short of the fire support coordination line.
- Processes immediate close air support requests.
- Deconflicts airspace control measures and aircraft.
- Allocates attack aircraft to tactical air control party (TACP) terminal attack controllers according to the ground commander's priorities.
- Manages the joint air request net, the Air Force air request net, and the tactical air direction net.

See JP 3-09.3 for additional information regarding ASOC organization and functions.

3-56. An ASOC normally co-locates with the senior Army fires cell. It may be co-located with the theater Army OCP, the corps main CP, or a division main CP. Three principles guide its placement:

- Do not split up the ASOC other than when it is displacing. While displacing some degradation in capability will occur.

- Locate the ASOC in a relatively secure location. Due to the firepower the ASOC can potentially bring to bear, its loss due to enemy action could seriously affect ground forces.
- Place the ASOC where its communications systems can cover the largest area. The depth at which the ASOC controls operations depends a great deal on its ability to both communicate with forces and maintain situation awareness on targets, threats, and other factors.

3-57. The need for a relatively secure location has to be balanced by the ASOC's primary limitation. To control airpower, the ASOC needs to be able to communicate with the aircraft, which in most cases remains restricted by UHF (ultrahigh frequency) and VHF (very high frequency) line of sight. Best case, this could be as much as 100 nautical miles with an aircraft at 10,000-feet or higher. This distance is described as an arc from the transmitter. However, commanders must consider factors like radio power and antenna size. The furthest corner of the airspace the ASOC can control must include the fire support coordination line or a sanctuary from air attack for enemy forces might be created. In mountainous terrain, these distances may be considerably less, depending on the elevation of the radio antennas in relation to the surrounding terrain. Radio relays, Joint Surveillance Target Attack Radar System aircraft, and airborne forward air controllers can help the ASOC extend these distances.

### BATTLEFIELD COORDINATION DETACHMENT

3-58. The battlefield coordination detachment (BCD) is the Army liaison element provided by the theater army commander to the joint force air component commander (JFACC). The BCD has seven sections: headquarters, operations, plans, intelligence, air defense, airspace management, and airlift. (See figure 3-12.) The situation in the various combatant commands determines the location of the BCD. In theaters where a major combat operation is likely, the theater army will be assigned a BCD. One or more BCDs will be based in the United States and available for deployment to any theater army or directly to a division that requires the organization.

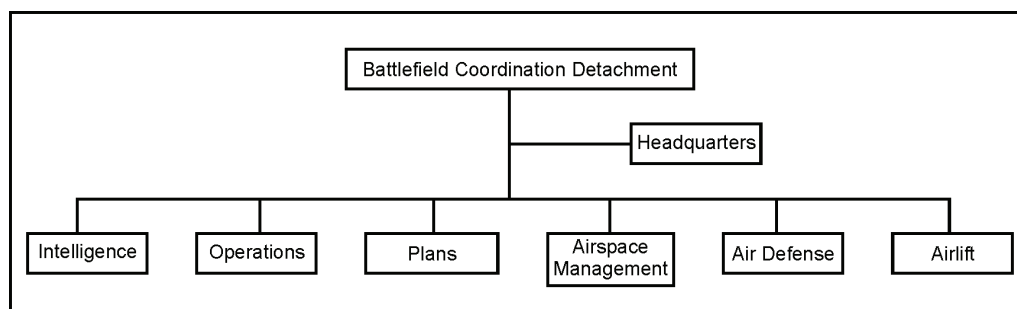

**Figure 3-12. Battlefield coordination detachment organization**

3-59. During operations, the BCD is co-located with the joint air operations center (JAOC). The JAOC is the operational facility in which the JFACC centralizes the planning, direction, and controlling functions for all theater air resources. Historically, the BCD has worked with the Air Force in this coordination role; however, it can also expect to work in contingency operations with Marine Corps and Naval officers who are the JFACCs.

3-60. Basically the BCD facilitates the synchronization of air support for Army operations. The BCD monitors and interprets the land battle for the joint force air component staff. It passes JFLC operational data and support requirements to the joint force air component and participating multinational forces. These requirements include requests for the following:

- Close air support.
- Air interdiction.
- Manned and unmanned reconnaissance and surveillance.
- Airlift support.

- Joint suppression of enemy air defense.

3-61. The BCD answers to the ARFOR commander and coordinates with and receives objectives, guidance, and priorities from the ARFOR G-3 through the echelon fires cell. Specific missions include processing land force requests for tactical air support, monitoring and interpreting the land battle situation for the JAOC, providing the necessary interface between the JFLC for the exchange of current intelligence and operational data, and coordinating air and missile defense and airspace control matters. It expedites information exchange through face-to-face coordination with JAOC elements.

3-62. The BCD eases planning, coordination, and execution of the following functions: C2, intelligence, fires, airspace management, information operations, airlift support, and theater air and missile defense (TAMD). To integrate the TAMD battle, the BCD supports the ARFOR TAMD cell responsible for TAMD in theater. The ARFOR commander specifies the role of the BCD to help coordinate TAMD active defense and attack operations with the JAOC. Additionally, the BCD supervises the Army air reconnaissance liaison officer teams and Army ground liaison officer augmentation teams that coordinate Army forces with Air Force reconnaissance, fighter, and airlift wings.

3-63. Department of the Army (DA) allocates one BCD per theater army. The BCD may support the theater army or be tailored to support a subordinate commander's operations. Normally, the BCD is assigned to the theater army and further attached to the highest ground operations headquarters, assuming the theater army is not the JFLC. (FM 100-13 has additional information on the BCD.)

### **ARMY AIR AND MISSILE DEFENSE COMMAND**

3-64. For MCOs, and in theaters where the GCC requires air and missile defense capabilities, the theater army receives an attached U.S. Army Air and Missile Defense Command (AAMDC). Figure 3-13 illustrates its composition. During a MCO, the AAMDC commander performs the role of senior Army air and missile defense (AMD) commander, the theater AMD coordinator, and the JFACC's deputy area air defense commander. The theater AMD coordinator directs attack operations, active defense, passive defense, and AMD. The AAMDC commander also participates in integrating theater operational protection. The AAMDC ensures unity and continuity of effort for AMD forces in theater. It integrates with global missile defense outside the supported JOAs in the AOR. Two deployable AAMDCs exist to conduct frequent, short-notice overseas deployments in support of the GCCs. Based on apportionment in the Joint Strategic Capabilities Plan, each deployable AAMDC maintains regional expertise and plans. The alignment and habitual association of AAMDCs and theater AMD brigades will be maintained as much as possible to enhance planning, training, leader development, and readiness.

3-65. The AAMDC headquarters synchronizes offensive and defensive AMD missions and helps integrate operational force protection in a joint, interagency, and multinational environment. Each AAMDC command post has an embedded modular early entry command post that, when not already forward deployed, can rapidly respond to contingencies. The AAMDC command support center serves as an institutional, industry, and knowledge-based center supplementing deployed AAMDCs. It provides the gaining theater army staff with technical support, planning, and expertise.

3-66. In the future, theater AMD brigades will normally include terminal high altitude air defense, medium extended air defense system, and Joint Land Attack Cruise Missile Defense Elevated Netted Sensors units. The brigades will also have the required headquarters battery and modular maintenance units. Currently they consist of a mix of Patriot and Avenger air defense systems supported by various sensors. (Signal support comes from an integrated theater signal battalion.) Enhanced area air defense system units may be assigned to the theater AMD brigade for ASOS. These units execute wartime executive agent responsibility missions or augment tactical AMD systems prior to medium extended air defense system fielding. The theater AMD brigade headquarters can provide command and control for protection and other missions as required by the theater army commander. Each AMD battalion of the brigade has the requisite command and control capability to function as a theater AMD task force, capable of fighting any combination of different AMD batteries.

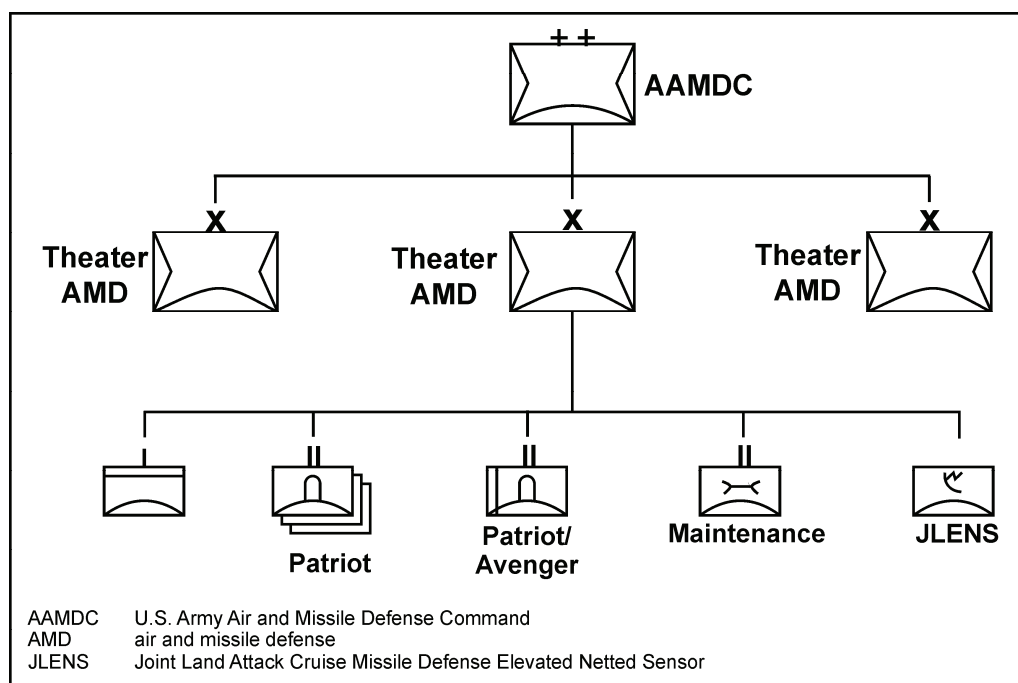

**Figure 3-13. Theater AAMDC and AMD brigade**

3-67. While oriented primarily on the theater-level fight, the brigade could also provide supplemental forces. The brigade can provide batteries to supplement the other theater AMD fights and AMD task forces at division level—typically under OPCON or tactical control to the division’s supporting maneuver enhancement brigade (MEB). It can also provide other joint forces, such as an Air Force air expeditionary force task force, a MEF, or global missile defense missions as required.

### **OTHER POTENTIAL THEATER-LEVEL COMMANDS AND BRIGADES**

3-68. Based on theater requirements, DA tailors the theater army. The operation’s mission and size determine the appropriate headquarters and forces received by the theater army. The theater army commander may elect to support the theater with functional commands and brigades or to designate certain of the theater’s normal multifunctional commands to control the activities of these additional functional commands and brigades. Some other potential theater-level commands and brigades are discussed below.

#### **Army Field Support Brigade**

3-69. The AFSB shown in figure 3-14 on page 3-22 provides the supported commander a point of contact for three different agencies—

- Defense Contract Management Agency.
- U.S. Army Corps of Engineers.
- Defense Logistics Agency.

3-70. The individual functions of these agencies are discussed elsewhere in doctrine and regulations. The AFSB provides supported commanders with efficient and effective contracting for required supplies, emerging technology, and the use of real estate to support current and future operations. They provide the operational commander with a substantial return on investment by obtaining goods and services on time and at the lowest total ownership cost for Soldiers. The AFSB supports the operational commander but remains under OPCON of its parent organization. This parent organization is the Army Sustainment Command, which is a major subordinate command of the Army Materiel Command. (See FMI 4-93.41.)

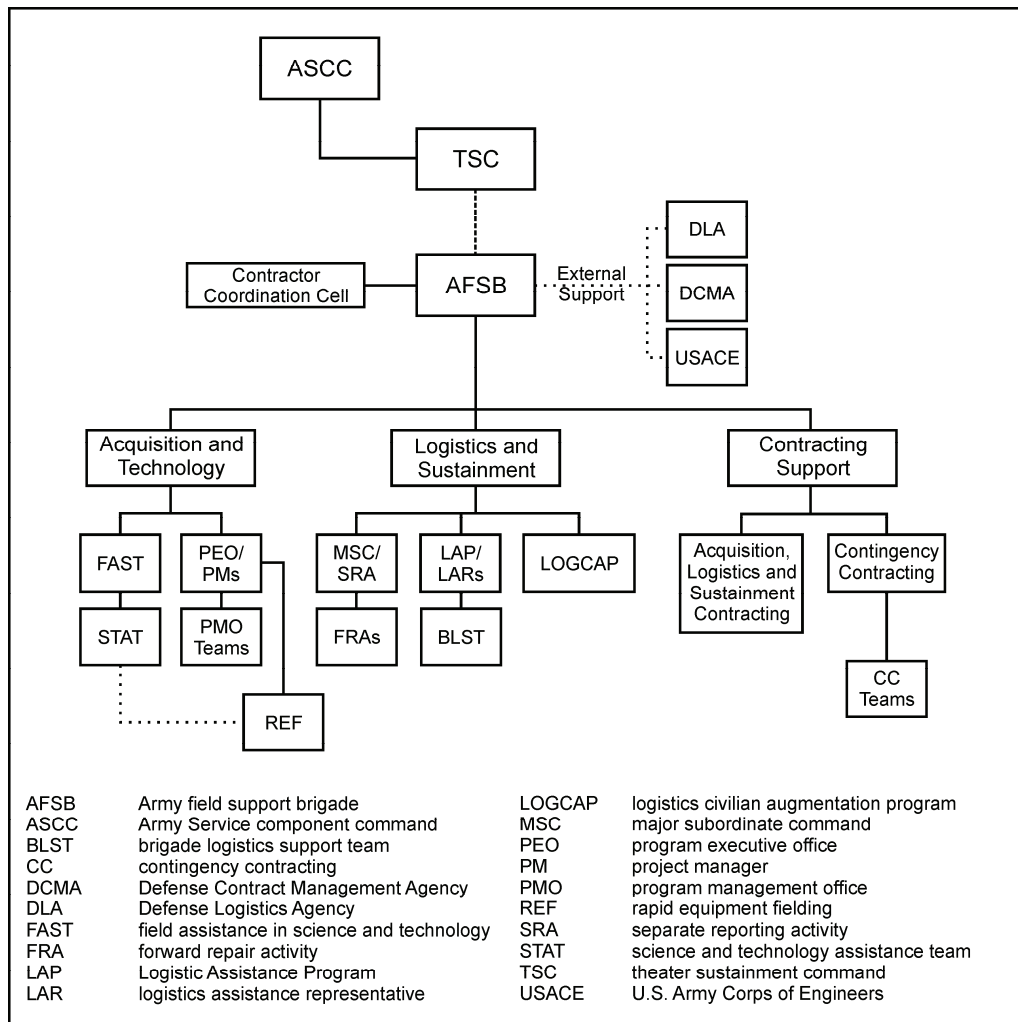

Figure 3-14. Army field support brigade

### CBRNE Operational Headquarters

3-71. The chemical, biological, radiological, nuclear, and high-yield explosives (CBRNE) operational headquarters serves as the Department of Defense operational headquarters for global weapons of mass destruction (WMD) elimination operations in support of national combating WMD objectives. This headquarters provides C2 for Army and joint forces conducting WMD-elimination and other WMD-related operations. Additionally, this headquarters provides trained and ready Regular Army CBRNE forces capable of responding to a wide range of operations from small-scale contingencies to major combat operations. The CBRNE operational headquarters provides CBRNE- and WMD-related technical expertise to supported commanders. It helps set conditions for the long-term elimination of WMD production sites and other related activities. When directed, the headquarters may also provide training oversight to designated Army Reserve and Army National Guard CBRNE forces.

3-72. The CBRNE operational headquarters is a multifunctional headquarters consisting of chemical, explosive ordnance disposal, nuclear, intelligence, signal, and medical personnel that can be tailored and task-organized based on the mission and the situation. The CBRNE operational headquarters' OCP can also serve as a JTF headquarters for WMD-elimination and WMD sensitive site exploitation missions.



3-73. The CBRNE operational headquarters supports contingency operations abroad while supporting homeland security operations domestically. Concurrently with overseas campaigns, the CBRNE operational headquarters can provide support to civil agencies.

### Theater Engineer Command

3-74. In major combat operations as well as during other significant stability or civil support operations, the theater army normally receives a full theater engineer command. This is in addition to the one or more tailored engineer battalions attached to each MEB. See figure 3-15. The theater engineer command provides an organizational framework for the operational-level engineer effort in the AOR. In small-scale operations, a smaller modular C2 element will replace the full theater engineer command headquarters as required to support ongoing operations. This command focuses on reinforcing and augmenting tactical-level engineer efforts and developing the theater sustainment base. This focus involves planning, ensuring operational mobility, and coordinating all operational engineering assets. It also integrates Army geospatial capabilities with geospatial operations and supervises the direction of construction, real-property maintenance activities, line of communications sustainment, engineer logistics management, and base development. The theater engineer command has primary responsibility for theater infrastructure development.

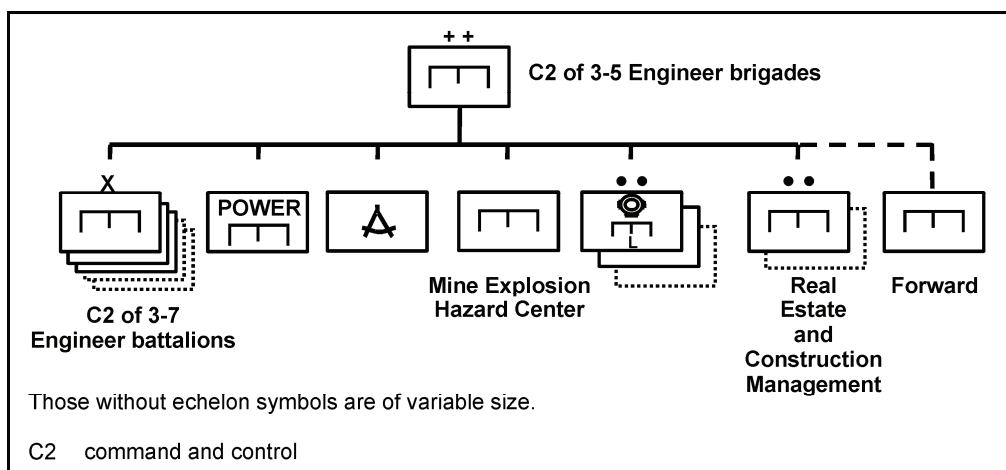

**Figure 3-15. Notional theater engineer command**

3-75. The theater engineer command develops plans, procedures, and programs for engineer support for the theater army. This development includes requirements determination, mobility, countermobility, general engineering, power generation, area damage control, military construction, topography, engineering design, construction materials, and real property maintenance activities. Engineer units oversee infrastructure planning, development, construction, and maintenance. The theater engineer command works closely with the U.S. Army Corps of Engineers and engineer centers of excellence on these and other matters. This command receives policy guidance from the theater army based on the guidance of the GCC's joint force engineer. The theater engineer command headquarters element provides staff supervision over operational-level engineer operations in the AO and reinforces engineer support to all theater Army forces. The theater engineer command also supports joint and multinational commands and other elements in accordance with lead Service responsibilities as directed by the supported JFC. It provides policy and technical guidance to all Army engineer units in the AO. This headquarters maintains planning relationships with the theater army and joint force staff engineers to help establish engineer policy for the theater. It maintains required coordination links with Department of Defense agencies, such as the National Geospatial-Intelligence Agency, other Service, and multinational command engineering staffs. It also maintains required coordination links with the TSC, the theater military police command or brigade, the medical deployable support command, senior civil affairs organization, and other units. In some theaters, a tailored engineer brigade

will provide theater-level engineer support. The engineer brigade commander provides similar expertise and capability to the theater army, as the commander of theater engineer command, but at a reduced level.

### Theater Aviation Support

3-76. Operational-level Army aviation support, is normally provided by a theater aviation command or brigade. (Figure 3-16 shows a command.) DA tailors the theater aviation command or brigade to provide maximum flexibility for the AOR in which it operates. This command provides theater-level, fixed- and rotary-wing aviation support to the theater army's major subordinate commands. It also provides reinforcing aircraft to combat aviation brigades in the AOR; supports reception, staging, onward movement, and integration for theater aviation units; and provides theater airfield operations and air traffic services. It consists of a theater aviation brigade (composite), fixed-wing and utility aircraft, theater aviation brigade, and a theater airfield operations group.

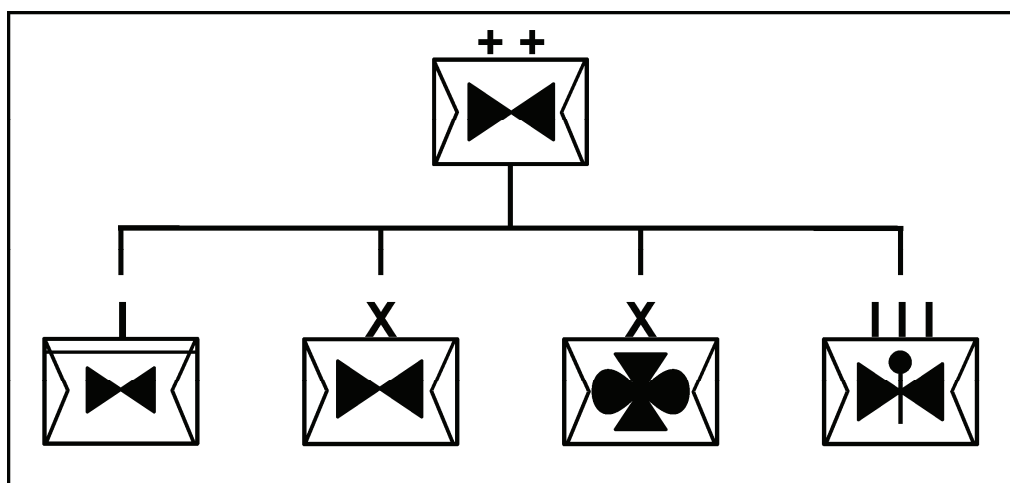
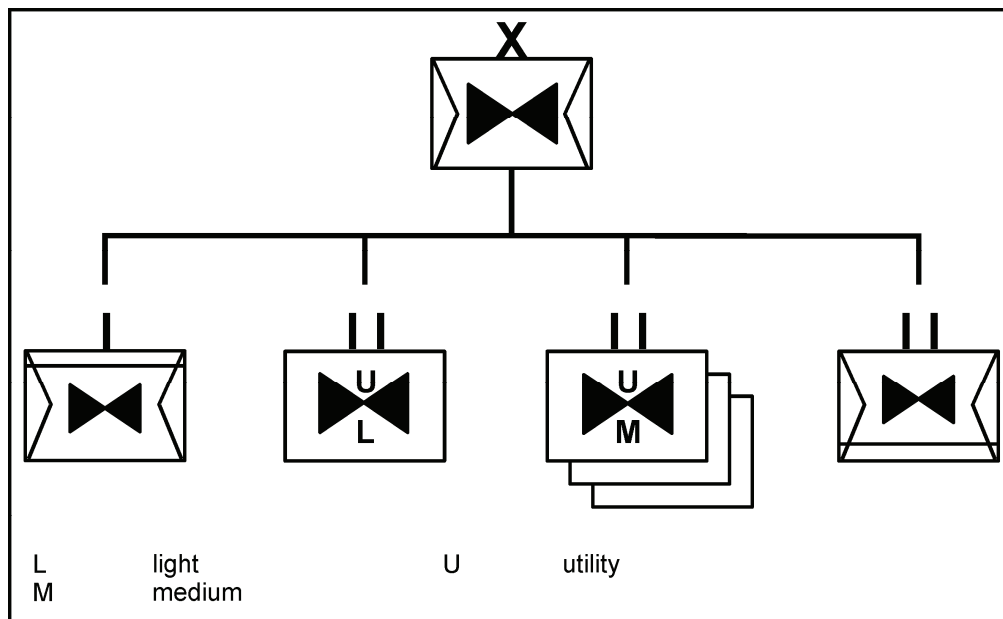

**Figure 3-16. Notional theater aviation command**

3-77. The theater aviation command operates short takeoff and landing fixed-wing aircraft that provide support to sustainment organizations in the JOA. This command can support sustainment area security operations with assault, command and control, and reconnaissance and attack aviation.

3-78. The theater aviation composite brigade provides theater-level fixed- and rotary-wing C2 aircraft, medical evacuation, and transportation of supplies, equipment, and personnel in the theater. It consists of three general support aviation battalions, a fixed-wing battalion, and an aviation support battalion. Special operations forces, sensitive site exploitation teams, and bio-detection companies employing the long range standoff biological detection system rely heavily on this brigade for in-theater support. Likewise, it may be involved in the aerial evacuation of enemy prisoners of war and detainees. The theater general support aviation brigade's general support aviation battalions provide the personnel and aircraft that constitute the aviation elements that support the theater army commander.

3-79. The theater aviation brigade is an additional asset provided at theater level. It conducts planning coordination, synchronization, integration, and execution of assault, heavy-lift, and medical evacuation support to theater troops, corps, divisions, or BCTs. (See figure 3-17.) It can conduct joint or multinational support and provide assets in support of joint security or support operations. While tailored for a specific mission, it normally consists of one general support battalion, three assault battalions, and one aviation support battalion.



**Figure 3-17. Theater aviation brigade**

3-80. Theater airfield operations and air traffic elements will form two theater airfield operations groups with five subordinate airfield operations battalions each. The two theater airfield operations groups will form with Army and Army National Guard to support theater aviation commands. Airfield operation battalions are designed to support airfield and heliport operations at the theater level. The airfield operation battalion satisfies mission airfield responsibilities at a designated location identified by the theater army.

3-81. Multifunctional combat aviation brigades (CABs) with reconnaissance and attack assets will normally operate under the command and control of subordinate corps and divisions. However, the theater army may be assigned a CAB to meet GCC requirements. These CABs may also provide the theater army commander with attack capabilities or provide operational support to another component. (See FM 3-04.111 for detailed doctrine on aviation brigades.)

### Theater Chemical Support

3-82. Army chemical units are indispensable to theater protection operations. They can support operations as individuals, teams, or units. A mix of different units—decontamination units, chemical, biological, radiological, and nuclear (CBRN) reconnaissance elements; smoke units; and biological defense units—is often necessary to properly balance capabilities between protection and mission accomplishment. Forces deployed in countries with CBRN weapons capabilities or chemical industrial complexes require support from both chemical staffs and units. They provide training support and technological and consultative operations. These operations include nuclear accident- and incident-response operations and chemical accident- and incident-response operations. The latter involves CBRN material, flammable and combustible substances, and industrial chemical hazards. In addition, the U.S. Army Nuclear and Chemical Agency provides nuclear employment augmentation teams to support ARFOR or JFLC commanders in tactical nuclear weapons targeting and consequence analysis.

3-83. In a MCO or small-scale contingency, CBRN defense and smoke and obscurant units are task-organized into battalions either on an area or functional basis based on the factors of METT-TC. Chemical companies are not permanently assigned to battalion headquarters in order to maintain a high level of flexibility in the contingency operations. Area-based battalions have a mixture of CBRN defense and smoke

units assigned. Functionally based battalions conduct either CBRN defense or smoke and obscurant missions.

3-84. The CBRN force organization in a theater depends greatly on the threat. U.S. forces are organized and trained to operate against a sophisticated threat capable of using CBRN munitions. Based upon the actual factors of METT-TC prevailing in the theater, the theater army or ARFOR commander tailors available CBRN defense forces to meet the specific situation. Normally the commander assigns CBRN defense responsibilities in a contingency to a subordinate unit, such as a division, MEB, or theater sustainment command. Frequently, an active duty chemical battalion will provide CBRN defense support for a larger force until reserve component units can arrive. Early arriving CBRN defense units must be aware of the large area occupied by tactical units as well as the Army communications zone or joint security area. The senior chemical unit commander, the staff, and the functional units assigned normally perform CBRN defense missions in support of the joint force in addition to their own Service.

3-85. Figure 3-18 shows the command and control relationship between the theater army commander, the CBRN brigades, and supported units. FM 3-11 documents the exact capabilities of CBRN organizations and assigned responsibilities of CBRN staff officers at different echelons.

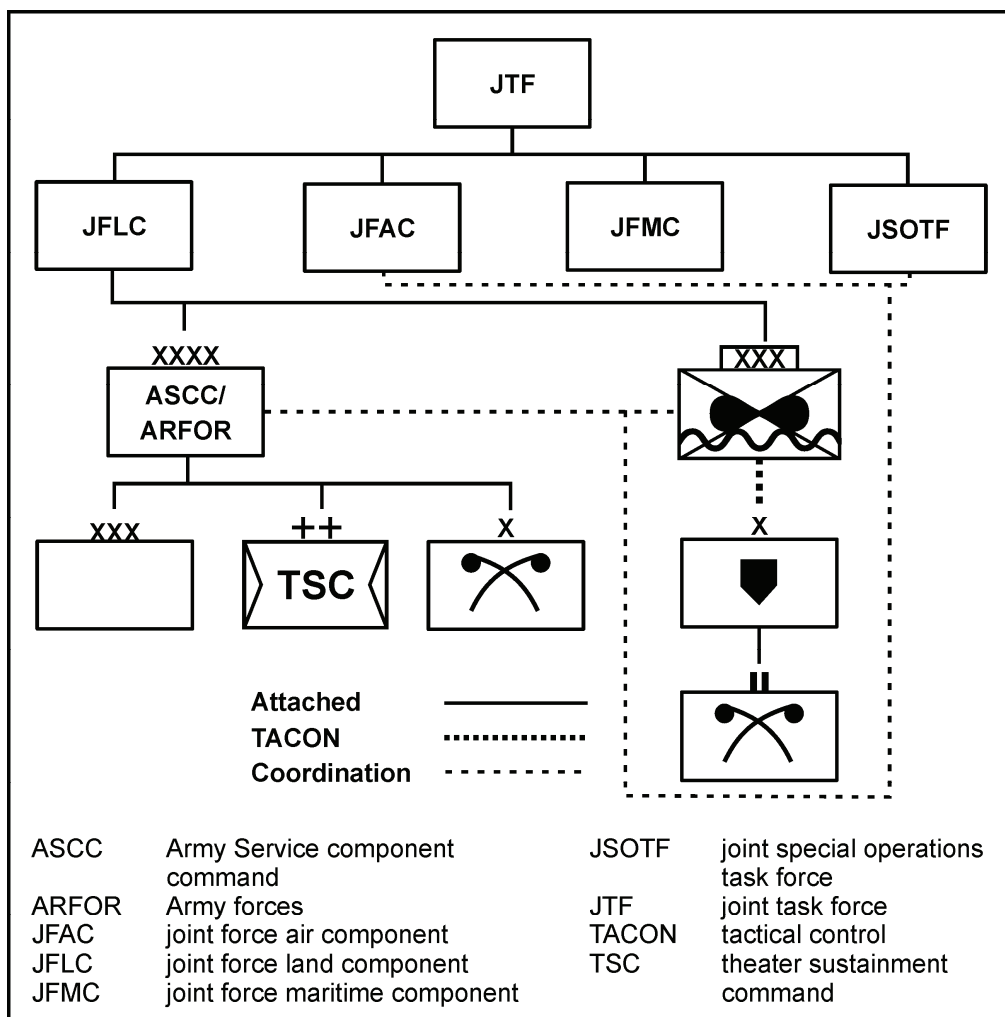

Figure 3-18. Chemical force command control relationships

3-86. The theater army or ARFOR commander normally allocates the CBRN defense and smoke and obscurant units in mature theater in the following manner:

- One chemical brigade per JOA.
- Three bio-detection companies per AOR or JOA.
- One chemical company (heavy) per port of debarkation (air/sea).
- Five chemical companies (heavy) per AOR or JOA.
- One bio-detection company per MEF.
- One chemical company (heavy) per MEF.
- Two chemical companies per MEF.

3-87. Approximately 25 percent of all chemical units are in the Regular Army. Most chemical units are assigned to the USAR. They are located in every region of the United States. As a result, the number of CBRN defense and smoke units available to support the joint security area may be inadequate, at least initially, until the President or Secretary of Defense orders unit activations.

3-88. As the JOA matures, the theater army or ARFOR commander organizes incoming chemical units into battalions and brigades. A typical allocation of theater CBRN assets is as follows—

- One brigade is retained by the theater army and is OPCON to the deputy commanding general for support or the joint security area coordinator or is assigned to the TSC.
- One battalion—tailored appropriately with the factors of METT-TC—is attached to each MEB. This includes the MEB that normally supports the MEF. If the threat exceeds the capacity of a single battalion, a CBRN brigade may be used.
- A CBRN force—brigade or separate battalion (conventional or technical escort)—may be task-organized to the 20th Support Command (CBRNE) for WMD-elimination operations.

### **Theater Military Police Command**

3-89. A military police (MP) command is normally established and attached to the theater army in a mature theater with several MP brigades and a criminal investigation division (CID) group. (It does not exercise C2 over the CID group but provides required sustainment.) When established, the commander of the MP Command serves as the theater army provost marshal and is normally also designated as the commander of detainee operations.

#### ***Military Police Brigades***

3-90. A MP brigade provides maneuver and mobility support, area security, internment/resettlement (I/R) operations, law and order, and police intelligence operations in the joint security area, ASCC sustainment area, or in a division AO. While normally a theater-level asset, a MP brigade may be assigned or attached to a division when required by the number of MP units assigned to the division. MPs regulate and enforce main supply routes along key lines of communications. (The brigade may serve as a C2 headquarters over a mobility corridor designed to secure a main supply route.) MPs conduct maneuver and mobility support during the reception, staging, onward movement, and integration process. MPs also provide area security before commencing offensive operations. The ASCC or ARFOR provost marshal coordinates MP unit support to facilitate sustainment operations and security requirements in a maturing theater.

3-91. These brigades support users of lines of communications in the theater army's sustainment area or the joint security area by aggressively patrolling areas along these routes. They play an important role in securing designated areas by performing combat operations against the threats located there. When properly augmented, a MP brigade headquarters may serve as the echelon tactical combat force headquarters. These brigades provide maneuver and mobility support on the main supply routes leading into division support areas. They implement the plans of host-nation and U.S. staff elements to control the forward movement of combat resources along theater lines of communications.

3-92. If resources exist, the MP brigade provides escorts to move U.S. noncombatants—if present—from assembly areas to theater embarkation terminals. Until MP battalions (I/R) arrive in theater, MP units also perform detainee, confinement, and other operations normally performed by the MP I/R units.

3-93. The organization of an MP brigade includes the following:

- A brigade HHC.
- Up to six MP battalions composed of both combat support MP battalions (each with up to six companies) and MP I/R battalions. A single MP brigade may not have more than three MP battalions (I/R).
- Numerous customs, law and order detachments, and military working dog teams.

The theater army commander may attach an MP brigade to a division when the mission or number of MP units assigned to that headquarters makes this a viable course of action.

3-94. The MP brigade may have military working dog teams assigned or attached to detect the presence of explosives or narcotics in support of all five MP functions. These teams can also support patrols when not used in an explosive or narcotics detection role. Additionally, the theater army or ARFOR provost marshal or commander may attach or direct OPCON of customs teams to the MP brigade.

3-95. The MP brigade may be allocated MP companies to provide security for specific units or activities:

- Theater army, ARFOR, or JFLC command posts.
- The theater sustainment command headquarters and its major nodes, such as the theater distribution management center.
- Key communications and information system nodes.
- Lines of communications seaports, airfields, and railways.
- Theater ammunition storage areas.
- Theater petroleum terminals and pipelines.

However, the factors of METT-TC determine the exact number of battalions and companies assigned. MP companies or battalions may be attached to MEBs with AOs located in the theater army's sustainment area or joint force security area.

3-96. Normally a MP brigade is not assigned an AO. However, if a MEB is not available, the MP brigade may be assigned an AO that coincides with the territorial responsibility of the supported commander. The MP brigade commander assigns the MP battalion's AO by the above factors as well as by the factors of METT-TC. For example, an MP battalion's AO may be a large population center in which sustainment complexes and main supply routes are located. However, as employment factors and the commander's needs change, so will the AO. The MP brigade commander moves and tailors forces to meet the current and projected mission requirements.

3-97. All persons held in Army custody are given humane care and treatment from the moment of custody to their final release according to U.S. and international laws and treaties. The policy applies to detainees, dislocated civilians, and confined U.S. military personnel. This policy is equally binding on all U.S. forces. (FM 3-19.40 provides the Army doctrine on internment operations.)

3-98. The theater army or ARFOR commander supports U.S. laws, regulations, policies, and international agreements by providing personnel, administrative, morale, internment, resettlement, and confinement services for the theater of operations. MPs receive, process, and safeguard all detainees. Each category of detainee is segregated from the other types whenever possible. The MP battalion (I/R) provides this support. However, since most I/R units are in Reserve Components, the initial I/R operations (as mentioned above) may have to be conducted by a combat support MP battalion. Once an I/R unit arrives in the AO, it is responsible for—

- Providing control of detainees and dislocated civilians.
- Commanding and controlling all subordinate I/R units.
- Coordinating with OGAs, host-nation personnel, military territorial organizations, civilian police authorities, and nongovernmental organizations on matters pertaining to I/R operations.

- Controlling, employing, and releasing detainees as set forth by the Geneva Convention and other international laws and by the United Nations and other government bodies.
- Handling U.S. military prisoners.

The MP battalion (I/R) is normally attached to the theater MP command or to a MP brigade.

3-99. If the United States decides to transfer captured detainees to the host nation or to another nation, the United States must ensure that the nation is a party to the Geneva Convention and is willing and able to comply with the convention. In this case, the number and type of I/R MP units required for processing and retaining detainees before the transfer is based on the factors of METT-TC. Additionally, the MP battalion (I/R) includes I/R teams located at processing and transfer points and at the host-nation or third-country detainment facilities. The MP brigade or MP battalion (I/R) will supervise these dispersed teams. The MPs ensure that the host nation or the third country provides adequate care and security of U.S.-captured detainees and that accountability is maintained according to the Geneva Convention.

3-100. MP battalion (I/R) assets may include the following:

- An MP I/R liaison detachment.
- An I/R information center.
- An MP combat support company.
- An MP I/R battalion headquarters.
- MP I/R (enemy prisoner of war/counterintelligence) detachments.
- MP I/R (confinement) detachments.
- MP guard companies (one or two).
- Military working dog teams.
- Processing squads, processing liaison teams, camp liaison teams, and evacuation teams as required to support detainee transfer or to conduct an out-of-theater evacuation.

#### ***Criminal Investigation Division Command***

3-101. Criminal Investigation Division Command (CIDC) operations help the theater army or ARFOR commander maintain discipline and order. These operations prevent or investigate crimes that reduce the command ability to conduct full spectrum operations. During the investigation of serious crimes, the CIDC concentrates its efforts on investigating serious crimes such as wrongful deaths, controlled-substance offenses, theft, fraud, sex crimes, and assaults. The CIDC also conducts sensitive and special investigations involving matters pertaining to senior Army officials and those associated with classified programs. The CIDC supports the operational commander with the following functions:

- Sustainment security that tracks and protects materiel and equipment from the manufacturer to the Soldier on the battlefield.
- Criminal intelligence, which includes the collection, consolidation, analysis, and dissemination of intelligence products, associated with criminal and terrorists activities targeted at Army interests.
- Criminal investigations of suspected war crimes and, in some cases, crimes against multinational forces and host-nation personnel.
- Protective-service operations that protect key personnel anywhere on the battlefield.

3-102. The CIDC is a direct reporting unit whose special agents in the field report through the CIDC's chain of command (detachment to battalion to group) to the CIDC command general. This general reports directly to the Army Chief of Staff and the Secretary of the Army. A MP group (CID) normally supports each theater army. The group is placed in general support of the theater, but remains under the control of the CIDC regional commander. Commanders of CIDC tactical units advise their supported commanders on criminal-investigation matters as appropriate although no formal operational command relationship exists.

3-103. The MP group (CID) ensures the connectivity among all CIDC units within and external to the theater. It establishes and maintains links with supported units and joint, interagency, and multinational authorities on matters pertaining to Army and CIDC operations. The group headquarters has a command sec-

tion, a detachment headquarters, an S-1, an S-2, an S-3, an S-4, a staff judge advocate, and a communications section. It can command up to six subordinate battalions.

3-104. Whenever possible, CIDC units co-locate with MP units. This provides unified MP support and facilitates sustainment support. Based on the factors of METT-TC, the MP group (CID) headquarters will co-locate with the supported theater army main CP. The group's subordinate MP battalion (CID) headquarters will likewise co-locate with the appropriate theater MP brigade when enabled to do so by the factors of METT-TC. (FM 3-19.1 contains additional information on the conduct of CIDC operations.)

### **Theater Information Operations Groups**

3-105. The Army's concept of information operations (IO) provides for theater information operations groups with specialized teams to support Army total IO requirements across the range of operations, emphasizing information infrastructure protection. Both Reserve Components (USAR and Army National Guard) provide theater information operations groups and teams to operational and tactical commanders to achieve dominance; therefore, expanding the Army's capability to perform IO. These teams, consisting of field support teams, vulnerability assessment teams, and computer emergency response teams, are allocated to theater armies or ARFORs. Additionally, these IO teams may also support Homeland Defense and State Department applications of information protection in the form of computer emergency response and vulnerability assessment. (FM 3-13 describes their operations.)

### **PSYOP Battalions**

3-106. A tactical psychological operations (PSYOP) battalion often supports the theater army support area. If the theater army OCP is operating as a JTF headquarters then a PSYOP battalion or task force will normally support the JTF's operations. PSYOP companies normally support each division with PSYOP detachments at the BCT-level. When operating as an intermediate tactical headquarters or as a JTF or JFLC headquarters, the corps may also be supported by a PSYOP battalion.

### **Army Space Support Teams**

3-107. Theater-level Army space support teams may include a Army space coordination element for management as well as Army space support teams, commercial exploitation teams, missile warning detachments, or other Army space elements. (FM 3-14 provides additional information on these teams.)

### **Army Public Affairs**

3-108. Modular session and resource control (SRC) 45 public affairs units augment organic public affairs sections at theater army, corps, and division for ARFOR operations. They also operate autonomously when the situation dictates. These separate public affairs units may—

- Establish a visitor's bureau for major combat operations.
- Use media support centers to facilitate media operations, conduct public affairs planning and training.
- Produce information products for internal and external audiences.
- Establish a broadcast center.

3-109. Units are available as support packages to theater army, corps, and divisions, as well as to joint task forces and U.S. commanders supporting multinational operations. Public affairs units are organized as public affairs operations centers, mobile public affairs detachments, broadcast operation detachments, and public affairs detachments. These units are highly mobile, modularly organized, and capable of rapid deployment to support the widest variety of contingency operations. (See FM 46-1.)

### **Army Liaison Detachments**

3-110. One or more Army liaison detachments are provided to theater armies based on the factors of METT-TC to interact with command and control elements of other Services and multinational forces.



Army liaison detachments provide the theater army commander a forward liaison element with major subordinate or parallel headquarters. They consist of staff officers with a broad range of expertise, capable of analyzing the situation, facilitating coordination between multinational forces, and assisting in cross-boundary information flow and operational support. In certain circumstances, these 26-Soldier teams are essential not only for routine liaison, but also in advising and assisting multinational partners in conducting planning and operations at intermediate tactical levels. These detachments can operate as a single entity for liaison with a major multinational headquarters, or provide three smaller teams for digital connectivity and liaison with smaller multinational headquarters.

3-111. These Army liaison detachments represent the theater army commander at the headquarters of other organizations or agencies for coordinating and promoting cooperation between the two organizations. These detachments doctrinally conduct coordination with the following:

- Combatant commander or another joint force commander.
- Ambassadors and their country teams, or other government agencies.
- United States Marine Corps (USMC), United States Navy, or theater special operations command or task forces.
- Host-nation or major multinational partners.
- Subordinate multinational commands with digital liaison teams.

3-112. Army liaison detachments can also be used to conduct liaison with subordinate headquarters and other organizations in accordance with the factors of METT-TC, such as—

- Subordinate U.S. units.
- Multinational forces.
- Nongovernmental organizations.

Appendix E of FM 6-0 discusses the duties and responsibilities of liaison officers.

3-113. These teams are requested to ensure coordination with all multinational ground elements. Contingency missions by these teams may be conducted anywhere with their actual number required and location determined by the factors of METT-TC. In addition to the team proper, each Army liaison detachments may be augmented with aviation, engineers, or other specialty officers. In addition, the team normally receives a signal support team from the supporting theater signal command with complete communications capability. (FM 100-8, when published as FM 3-16, will describe the capabilities of these organizations in more detail.)

3-114. Combat support coordination teams (CSCTs) assigned to the Eighth United States Army (EUSA) in Korea are similar to Army liaison detachments. Located with each of South Korea's three field armies, the CSCTs provide coordination and liaison for Combined Forces Command, U.S. Forces Korea, and EUSA. Due to the nature of their duties, these teams have a joint as well as Army documentation and staffing. While the forward CSCTs 1 and 3 are primarily operational, and have augmented staffs, CSCT 2 has a sustainment and joint security area focus and will evolve into the U.S. element of a Combined Rear Area Center during conflict. All the CSCTs serve to facilitate coordination for U.S.-unique aspects of combat, information, support, protection, and sustainment support.

### **Rear Area Operations Centers**

3-115. Theater army rear area operations centers may be used to augment the theater army staff if the theater army commander is designated as the joint security coordinator or if required by the factors of METT-TC. Additional rear area operations centers or rear tactical operations centers may be used to augment sustainment brigades by serving as base cluster operations centers to organize and supervise base clusters when the tactical situation warrants.

## **COMMAND POST SECURITY**

3-116. The theater army requires a security organization to provide close-in security of the bases and installations on which the theater army, corps, and division headquarters are located. The exact composition

and size of these security organizations will be based on the factors of METT-TC. These security organizations will reflect a mixture of maneuver units, MP units, Department of Defense police, and contracted support provided by private security companies. The host nation may provide security forces external to the actual command post itself.

## THE OCP AS A JOINT FORCE LAND COMPONENT HEADQUARTERS

3-117. A JFC can establish functional component commands to conduct operations. Functional component commands are appropriate when forces from two or more military departments must operate in the same dimension or medium or when forces need to accomplish a distinct aspect of the assigned mission. These functional components are the joint force air component, the JFLC, the joint force maritime component, and the joint force special operations component. The OCP can function as a JFLC headquarters with minimal USMC augmentation during the conduct of major combat operations. (See figure 3-19.)

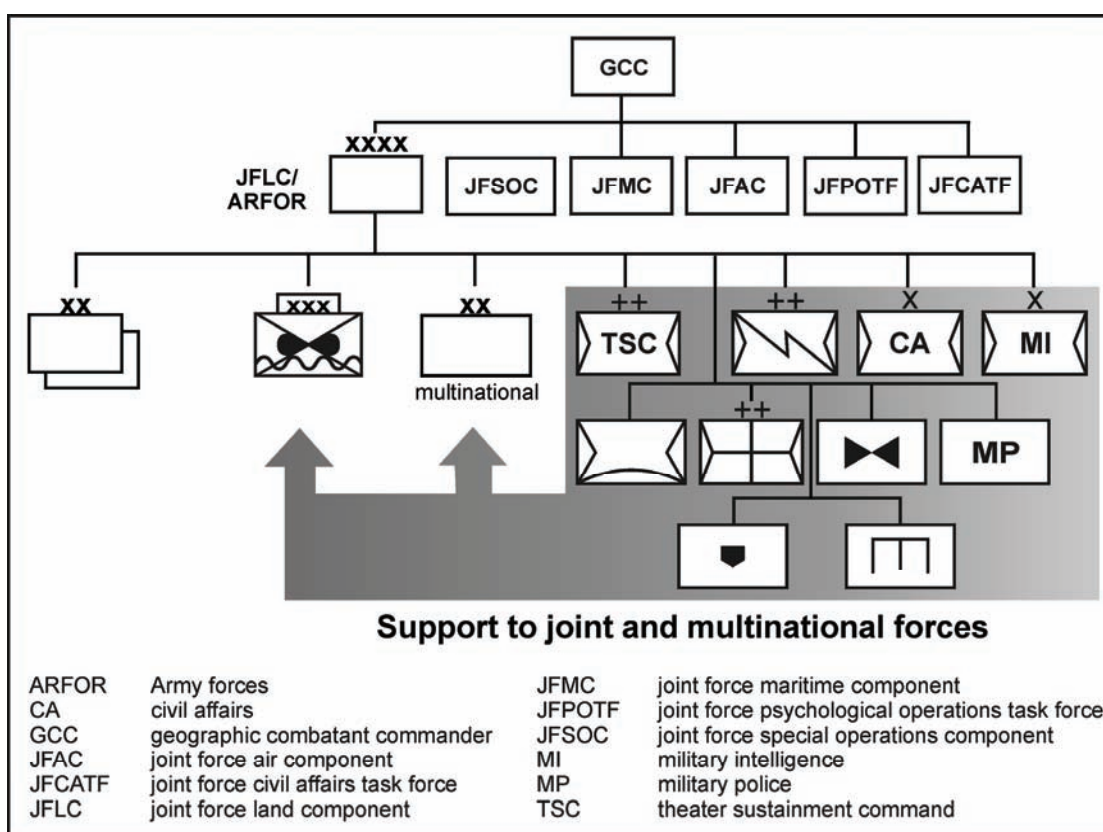

Figure 3-19. Example of theater army as a joint force land component

3-118. Usually the GCC elects to exercise direct operational control over joint forces without an intervening JTF headquarters during major combat operations. The GCC uses the theater army’s OCP as the base on which the JFLC headquarters will be formed if major combat operations involve large-scale land operations. Simultaneously, the theater army will continue to perform its ADCON and designated ASOS and CUL functions.

3-119. The OCP is organized, trained, and equipped to operate as a JFLC headquarters. As such, it accomplishes the following:

- Controls major land operations in a JOA.

- Orchestrates decisive, shaping, and sustaining operations in support of the campaign.
- Controls any combinations of corps—in their role as a senior tactical organization—and division formations, including joint or multinational equivalents. The mix may include Army modular division formations, Army of Excellence organizations, and Marine air-ground task forces.
- Requests and tailors additional tactical headquarters as needed for the control of operations. This may address the requirement to conduct large vertical maneuvers, reduce the span of control, or reduce complexity.
- Allocates BCTs; fires, aviation, battlefield surveillance, MEB, and sustainment brigades; and other functional brigades during operations. Management of BCTs and supporting brigades is a tactical function and will normally be exercised through divisions, the TSC, the theater signal command, or another theater-level functional command. Although it normally allocates BCTs and brigades to divisions (or equivalent formations) for tactical employment, the theater army may retain direct control of selected brigades for theater-level tasks.
- Deploys the OCP to the JOA to support the JFLC while continuing to fulfill theater army ADCON responsibilities.

3-120. Even when the OCP becomes a JFLC headquarters, the theater army's main CP retains its ADCON and designated ASOS and CUL responsibilities. The theater army exercises its support responsibilities primarily through its supporting commands and brigades and by tailoring C2 capabilities organic and attached to it. If required, supporting Army commands provide additional personnel to the theater army to allow it to continue performing its ADCON functions across the AOR.

3-121. If the scope of operations is so large as to require the GCC to organize multiple JOAs in the AOR, the theater army's main CP will remain responsible for ADCON functions throughout the supported GCC's AOR. (Previously designated ASOS and CUL functions will need to be reexamined at this scale of operations.) DA will provide additional OCPs or corps headquarters so that there is one per JOA. The Secretary of Defense will determine the rank and command relationship between the original theater army commander and the additional theater army commands added to the theater.

3-122. When complexity or span of command in a JOA necessitates the addition of an intermediate tactical echelon, the theater army will receive a corps headquarters to perform those functions. This allows the theater army commander to continue to function as the theater army and JFLC without overburdening command posts with tactical responsibilities.

3-123. The OCP will use Army doctrine primarily for internal operations. It will refer to joint doctrine primarily to determine what tasks to perform. Primary joint doctrinal references are JP 1, JP 3-0, and JP 5-0. Additionally, FM 3-31 discusses the organization and function of a JFLC headquarters organized along traditional staff section lines. However, commanders have the option of retaining the OCP's operational staff organization if they find it more efficient.

## THE OCP AS A JOINT TASK FORCE HEADQUARTERS

3-124. A joint task force is a joint force that is constituted and so designated by the Secretary of Defense, a combatant commander, a subunified commander, or an existing joint task force commander. The mission assigned should require execution of responsibilities involving a joint force on a significant scale and close integration of effort, or should require coordination of local defense of a subordinate area. JTFs are established to achieve operational objectives. The establishing authority dissolves a JTF when the purpose for which the JTF was created has been achieved or when it is no longer required.

3-125. The theater army has the capability to become a JTF headquarters with augmentation from a SJFHQ or an approved joint manning document. (See figure 3-20 on page 3-34.) Each GCC has a SJFHQ—core element—which is roughly 60 personnel with its associated contractor support. The SJFHQ—core element is a standing, coherent team of operational planners and joint C2 specialists led by a flag/general officer. Mission-tailorable, it incorporates extensive training for and knowledge of joint operations. It also adds an ongoing understanding of the combatant commander's theater perspective and knowledge of the AOR, key issues, and regional players. Joint Forces Command is developing joint manning documents for

various potential missions that will allow a designated Service headquarters, such as the OCP, to transform into a fully capable JTF headquarters when qualified individuals fill those joint billets.

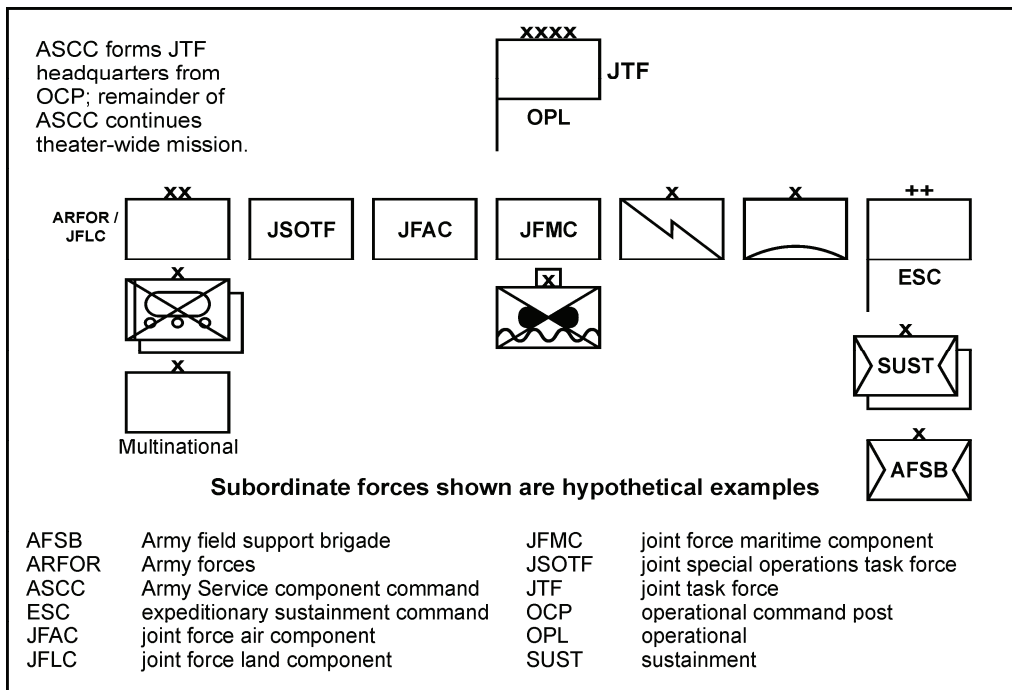

Figure 3-20. Theater army as a joint task force

3-126. Forming a JTF headquarters from the theater army’s OCP has the advantage of using a regionally focused headquarters with a more senior rank structure than that of a division. It has disadvantages in that it curtails the capability of the theater army to perform as a land component headquarters for another operation. The theater army is not designed to serve simultaneously as a JTF, a JFLC, and the Army Service component command. When deployed as a JTF headquarters, the theater army headquarters retains its ADCON responsibilities. Theater army commanders use their OCPs to provide the JTF headquarters with either deputy commanders or themselves as the JTF commander, while the main CP continues to perform its theater-wide functions.

3-127. Any Army headquarters assigned the mission of acting as a JTF headquarters will employ joint doctrine and procedures. JP 1 and JP 3-0 outline basic joint doctrine. JP 3-33 describes the organization and function of a JTF headquarters built along traditional staff lines. However, the theater army commander has the option of retaining the operational warfighting functional organization of the OCP when assigned the mission of providing a JTF headquarters.

## Chapter 4

# Corps Headquarters Organization

This chapter describes the corps headquarters organization. It also discusses employment of the headquarters as a joint task force (JTF), a joint force land component (JFLC), and as an intermediate tactical headquarters. The corps headquarters has no organic troops other than its headquarters battalion. All other forces previously under its command were transferred to the Army's force pool. It normally has no training and readiness authority over division headquarters, brigade combat teams, and supporting brigades within the United States under the Army force generation (ARFORGEN) process discussed in Chapter 2 until those units have been attached or placed under the corps operational control (OPCON) by U.S. Army Forces Command (FORSCOM). The headquarters design discussed in this chapter is pending review but represents the latest information available.

### PRIMARY ROLES OF A CORPS HEADQUARTERS

4-1. The modular corps headquarters design promotes joint and multinational operational planning efficiency. It ensures corps headquarters has essential command and control (C2) capabilities while remaining rapidly deployable to any geographic combatant commander's (GCC's) area of responsibility (AOR) to provide C2 for Army, joint, and multinational forces engaged in operations.

4-2. The corps design achieves four requirements. It can serve as an intermediate tactical headquarters, ARFOR, JTF, or JFLC headquarters. The corps headquarters can serve as a JTF or JFLC headquarters with little or no initial Army augmentation. As an operation progresses, time will allow the commander to structure the headquarters with individual or small element augmentees to exactly match operational requirements.

4-3. In major combat operations, the corps may be tasked to be an intermediate land tactical headquarters under the command of a JFLC. (See figure 4-1 on page 4-2.) Complexity, span of command, or multinational considerations may require using a second tactical controlling echelon above the brigades. When required, Department of the Army tailors the theater army with a corps headquarters to serve as this intermediate tactical level. As the major combat operation transitions to a protracted stability operation, the corps headquarters may become the joint force headquarters or multinational land component headquarters. When the corps acts as an intermediate-level tactical headquarters, it uses Army doctrine and procedures. FM 3-0 discusses operational art and full spectrum operations.

4-4. As an ARFOR headquarters, the corps headquarters coordinates administrative control support for Army forces in its joint operations area (JOA). This headquarters provides Army support to other Services, other government agencies, and multinational forces as required by the joint force commander (JFC). An ARFOR commander may not have OPCON of all of Army forces provided to the JFC; however, the ARFOR commander remains responsible for their administrative control.

4-5. A corps headquarters design provides a base structure on which to build a JTF headquarters for a small-scale contingency without additional initial Army augmentation. Normally this occurs when most forces involved are land units. It does require joint augmentation when assigned this mission. That joint manning may be provided by the GCC's standing joint force headquarters (core element) or by other joint manning, such as a joint manpower exchange program. The theater army provides augmentation to the corps headquarters with elements from the theater sustainment command, signal command (theater), and

other theater-level functional organizations. While acting as a JTF headquarters, the corps headquarters requires a separate ARFOR headquarters. The wide difference in roles and responsibilities between a JTF and an ARFOR headquarters requires two separate staffs. The corps uses joint doctrine and procedures when it acts as a JTF headquarters.

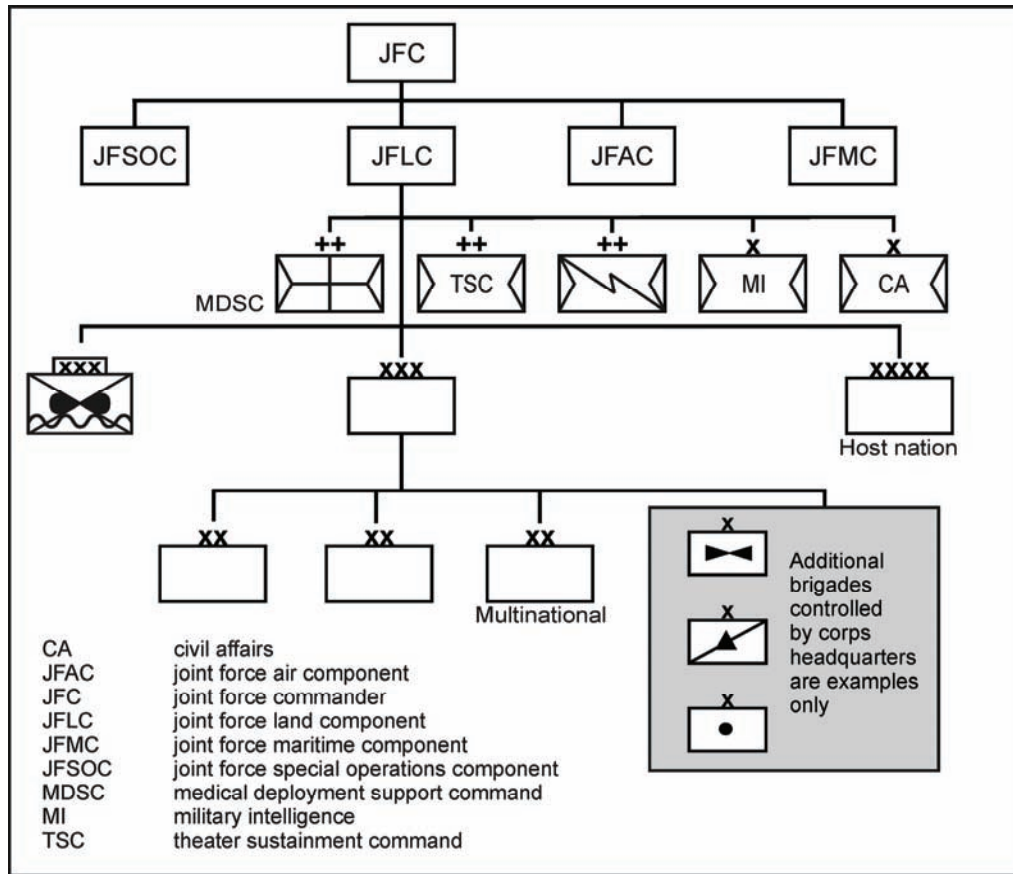
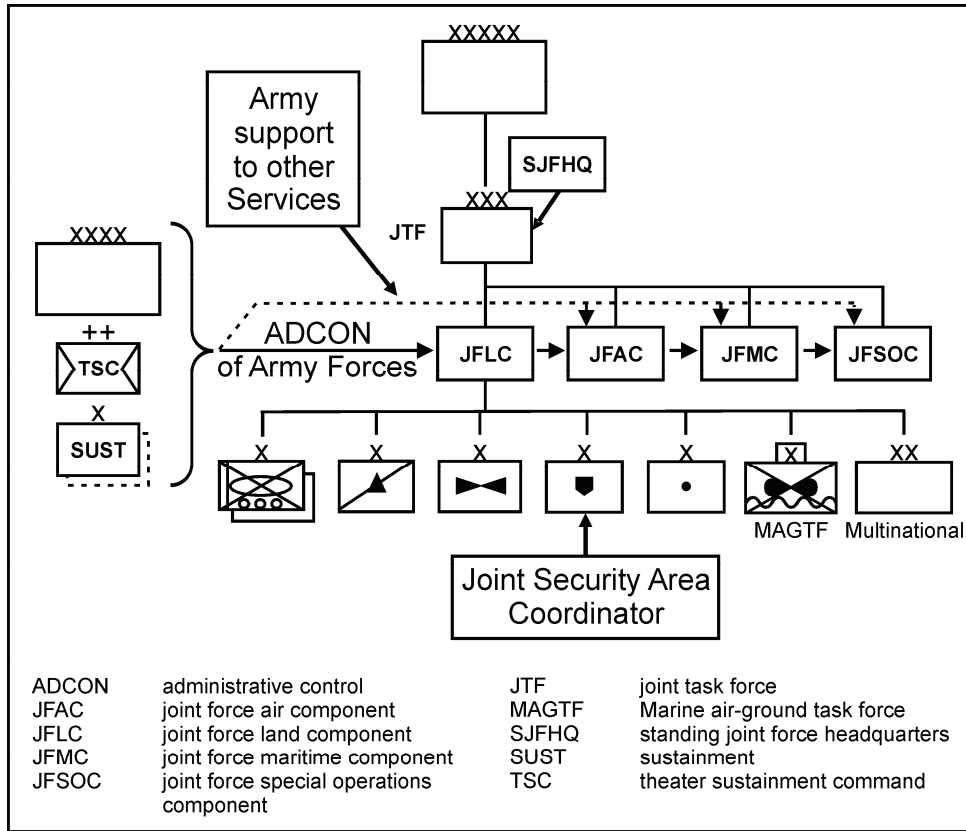

Figure 4-1. Corps headquarters as an intermediate tactical headquarters

4-6. With minimum joint manning, the headquarters can initiate operations as a JTF. Minimum manning equates to 20 other Service officers. This includes initiating campaign planning and deploying the corps early entry command post (EECP) and advance elements to establish initial C2 capabilities in the JOA. The headquarters can also initiate shaping operations and coordinate with host-nation and multinational partners in the JOA. Figure 4-2 shows a corps configured as a JTF headquarters. The conduct of sustained joint operations may require additional joint personnel. Note the multirole theater sustainment command with assets for providing sustainment across the JOA. An expeditionary sustainment command (ESC) may act as a forward command post for the theater sustainment command and may coordinate support for Army and joint forces. In this example, the maneuver enhancement brigade has been tailored to allow its commander to perform the duties of the joint security area coordinator. However, the corps deputy commanding general is routinely assigned those responsibilities outlined in JP 3-10.



**Figure 4-2. Corps headquarters as a joint task force headquarters**

4-7. The design of the corps headquarters provides a core headquarters on which to build a combined or joint force land component headquarters. (See figure 4-3 on page 4-4.) This headquarters can exercise operational control over land forces in a campaign or major operation. This may include controlling multiple Army, U.S. Marine Corps, and multinational division- and brigade-sized formations. The composition of the headquarters should roughly reflect the composition of the joint and multinational land forces involved. While acting as a JFLC headquarters, the corps headquarters will also perform duties of an ARFOR headquarters. Like the theater army's operational command post, the corps will use Army doctrine and procedures but refer to joint doctrine, such as JP 1, JP 3-0, and JP 3-31. These manuals list duties an operational command post performs as a JFLC headquarters.

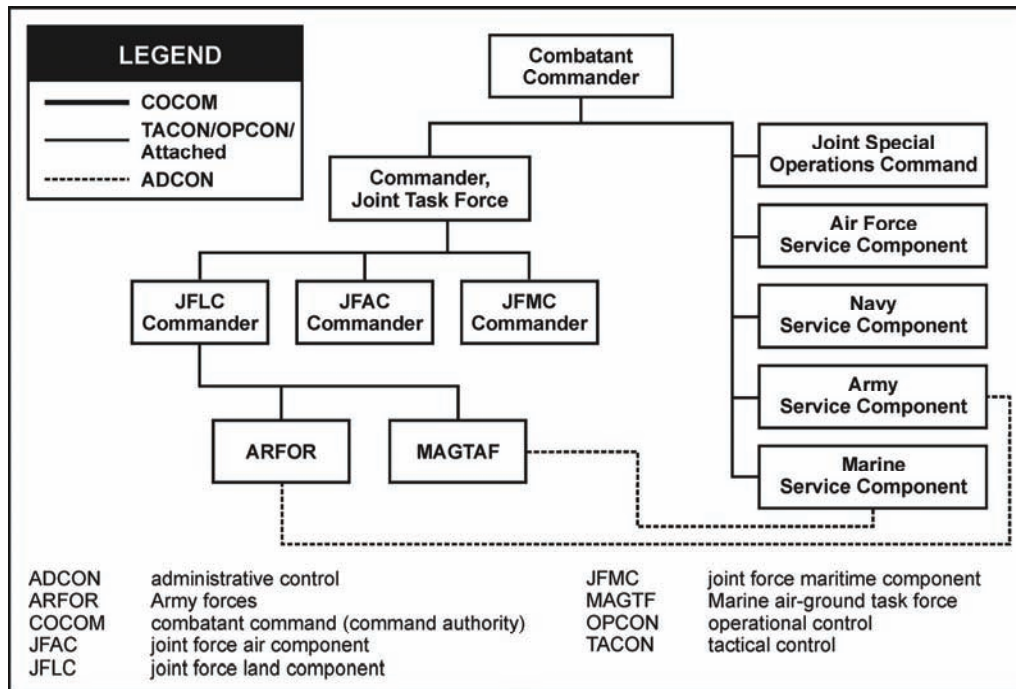

Figure 4-3. Corps headquarters as a joint force land component headquarters

## MODULAR CORPS HEADQUARTERS

4-8. Current plans call for the Army to field three modular corps headquarters. Figure 4-4 illustrates the basic design of the corps headquarters. The corps main command post (CP) is organized into integrating and functional cells. The tactical command post (TAC CP) is organized as a single integrating cell. The functional cells are based on the six warfighting functions. The basic design include the following characteristics:

- The headquarters is organized around one main CP and one TAC CP.
- The commander has a mobile command group (MCG).
- The corps headquarters battalion provides life support and network support to the headquarters. The corps normally tasks its subordinate units to provide security assets for each command node based on the factors of METT-TC. Alternatively, security could be provided by a mix of multinational, host-nation, or contracted assets. Regardless of its source, the corps headquarters security elements come under the control of the corps headquarters battalion commander.
- The corps is commanded by a lieutenant general.
- The deputy commanding general is a major general. The chief of staff (COS) and corps G-3 are brigadier generals.
- The corps does not possess a set of corps troops. It exercises OPCON over any mix of modular brigades, division headquarters, other Service, or multinational headquarters appropriate for its assigned mission.



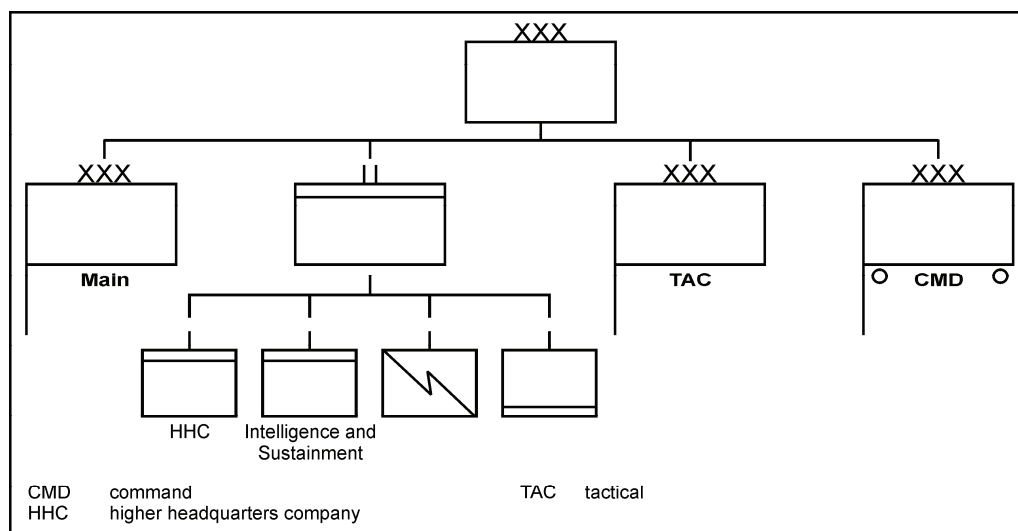

**Figure 4-4. Corps headquarters organization**

## CORPS COMMAND POSTS

4-9. The modular corps headquarters design, combined with robust communications, gives the corps commander a flexible CP structure. The corps headquarters has three command nodes: the corps MCG, main CP, and TAC CP. The corps CPs are organized around the warfighting functions and integrating cells.

4-10. The corps commander determines the sequence, timing of their deployment or movement, initial location and exact task organization of CPs based on the factors of METT-TC and the commander's visualization. The corps commander can change the functional capabilities and personnel of each CP from the table of organization and equipment (TOE) locations and functions to fit the C2 concept for the operation. The mission may dictate the co-location of the CPs or create a CP tailored from these assets, such as an EECF. Each CP performs specific functions by design and additional tasks assigned by the commander. The corps commander may command the corps from the deployed MCG, main CP, or TAC CP as dictated by the factors of METT-TC. In the C2 paragraph of the corps operation order, the commander details the authority, responsibilities, special instructions, and any changes to task organization of the corps CPs. The corps operations manual defines the responsibilities and functions performed by each CP. Individual headquarters variations from doctrine must be documented in the respective corps headquarters standing operating procedures (SOPs).

## MOBILE COMMAND GROUP

4-11. The MCG serves as the commander's mobile CP. It allows the commander to move to where the commander needs to be. The commander can make decisions while moving and interacting with subordinate commanders, staffs, and other organizations. The MCG allows the commander to—

- Provide personal leadership at the critical place.
- Make a personal assessment of the situation.
- Maintain situational understanding while moving around the battlefield. It gives the commander continuous access to current relevant information.
- Travel with key staff officers necessary to provide relevant information.

4-12. MCG personnel are normally staff officers capable of operating the Army Battle Command System (ABCS) multifunctional display units and available communications assets. Mission dictates the makeup of the MCG. The corps commander selects the personnel for the MCG from corps headquarters based on the

situation. For example, when meeting with authorities in an austere theater, the commander may choose specific staff. This list may include the G-2, political adviser, interpreter, and chaplain with area culture and religious expertise in the MCG.

4-13. The MCG contains two armored HMMWVs, each with multifunctional display units, such as ABCS. The MCG has two 11B10 drivers assigned with space for three additional personnel before requiring further internal or external transport augmentation. The corps headquarters signal company provides communications capabilities. The corps headquarters does not contain internal air assets. Air assets to constitute an aerial MCG are tasked from the theater general support aviation brigade or other external resources.

4-14. Commanders position their MCGs where they can observe the corps decisive operation, maintain communications, and sense the battle. Each MCG requires the presence of a tailored security force. Internal or external resources can provide security elements. These elements can be U.S. military, multinational, host-nation, contracted, or from other capable sources depending on the type of security force required and procurement policy. To maximize survivability, the MCG relies on its small signature, speed, and electronic communications assets, in addition to temporarily co-locating with other headquarters when possible.

## **MAIN COMMAND POST**

4-15. The main CP is responsible for the continuity of corps operations. It synchronizes the conduct of the corps current operations and allocates available resources. It also oversees the conduct of future planning, analysis for current and future operations, sustainment coordination, and other staff functions. The main CP staff operates under the general supervision of the corps COS. The main CP serves as the primary planning CP and coordination CP for tracking sustainment issues, such as human resources, legal, resource management, provost marshal operations, civil affairs, public affairs (PA), and inspector general support.

4-16. The corps main CP performs the following functions:

- Controls current operations.
- Serves as the primary plans, analysis, and tracker of sustainment issues.
- Monitors and assesses current operations for their impact on future operations.
- Conducts planning for major operations and battles.
- Writes operation plans.
- Writes branch and sequential plans as required.
- Integrates intelligence activities into both current and future operations.
- Produces multisource intelligence products.
- Produces terrain products.
- Conducts information management.
- Coordinates and manages force structure to include initiating requests for forces and equipment.
- Participates in the targeting process.
- Coordinates stability operations within the area of operations (AO).
- Prepares and maintains running estimates, plans, and orders to support future operations.
- Assesses the conduct of sustainment operations.
- Prepares all reports required by higher headquarters.
- Performs other C2 functions as designated in paragraph five (C2) of the operations order.

4-17. The main CP is functionally organized into a mix of warfighting functional and integrating cells to facilitate staff communications and interaction. (See figure 4-5.) All warfighting functions are represented or available to serve temporarily in the current operations and plans integrating cells. The main CP lacks the organic equipment to conduct C2 on the move, so it must operate in a stationary mode. It is 50 percent mobile with organic assets and requires two lifts to displace. Detailed internal staff SOPs outline the CP's various configurations and functions of assigned individuals when those functions vary from established doctrine. Flexible configurations accommodate the use of different types of existing buildings found in the AO and losses of equipment. The internal SOP should account for both temporary and long-term configurations.

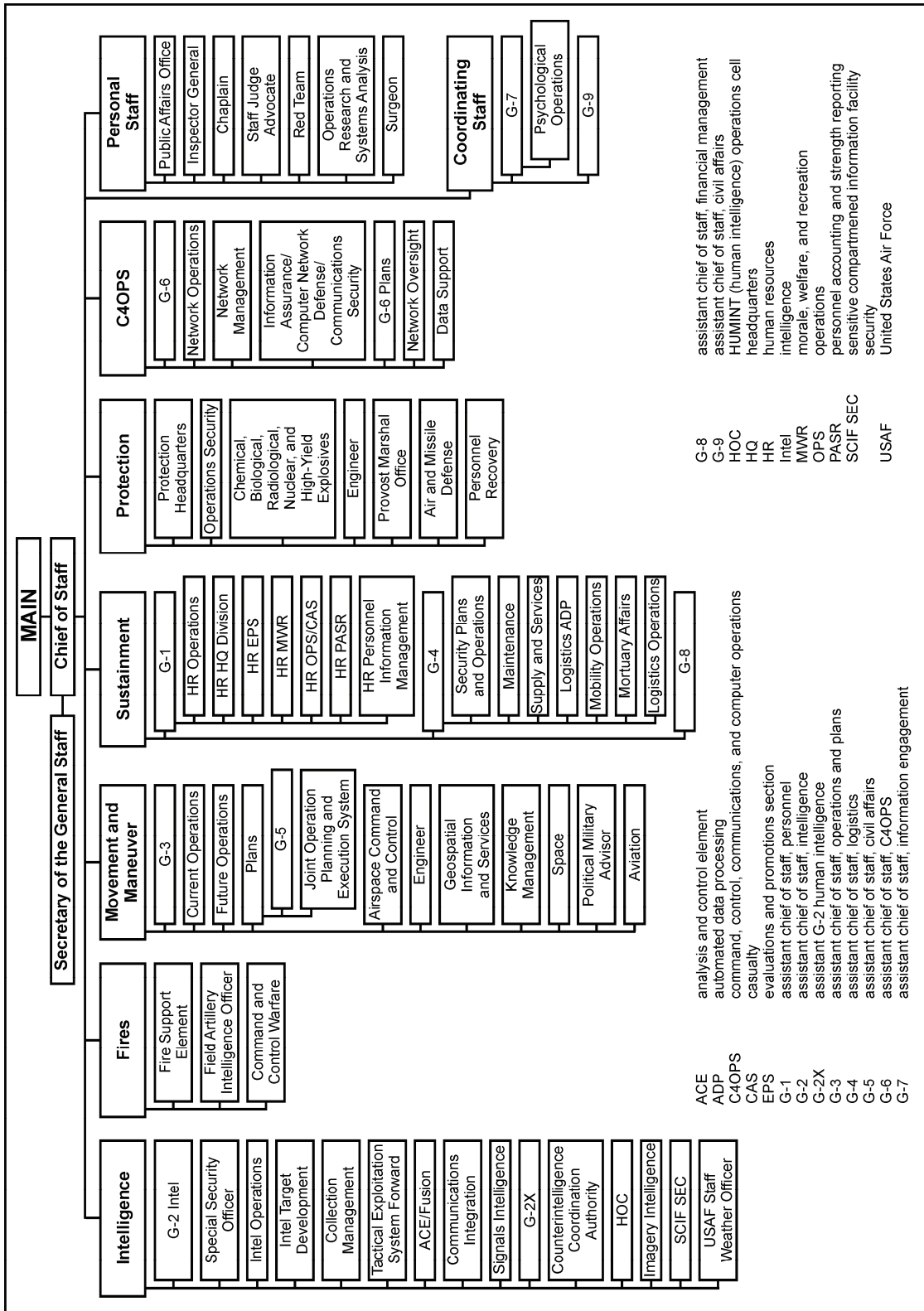

Figure 4-5. Corps main command post organization

4-18. The commander determines where to locate the main CP. The main CP does not have CP platforms for work areas, so it should be established in built-up areas using maintenance facilities, warehouses, or other buildings able to accommodate all personnel and equipment. (See FM 6-0 for a detailed discussion of considerations for locating CPs.)

**Headquarters Element/Command Group**

4-19. The headquarters element provides administrative support for the corps commander, serves as the focal point for liaisons, and orchestrates a synchronized staff effort. The headquarters element consists of the COS, the secretary of the general staff (SGS), organic liaison officers (LNOs), and supporting personnel. The COS supervises and trains the staff and oversees the main CP’s functions. Normally the commander delegates authority to the COS to manage the staff. The COS frees the commander from routine details and passes pertinent information and insight from the staff to the commander and from the commander to the staff. (FM 6-0, appendix D, details COS and SGS staff duties and responsibilities. FM 6-0, appendix E details LNO duties.)

4-20. The corps headquarters is usually augmented with LNOs from other government agencies (OGAs), nongovernmental organizations (NGOs), international organizations, and joint or multinational headquarters. (JP 3-16, JP 3-8, and FM 3-05.40 list a number of the prominent NGOs and international organizations.) These LNOs are located in CPs and cells, as necessary, to best facilitate operations.

**Current Operations Cell**

4-21. The current operations cell is the heart of the main CP. (See figure 4-6.) The current operations cell of the main CP controls the corps operations except when it displaces. It displays the common operational picture (COP) and conducts shift change, assessment, and other briefings as required. The current operations cell is an integrating cell that provides information on the current status of corps operations to all corps staff members. All warfighting functional cells and many of their subordinate elements have representatives in the current operations integrating center as does the personal and coordinating staff elements that are not part of the warfighting functional cells. In the current operations cell, information is exchanged and the current activities of the entire staff are coordinated. From here, the COS guides the staff and supervises activities of all cells in the main CP.

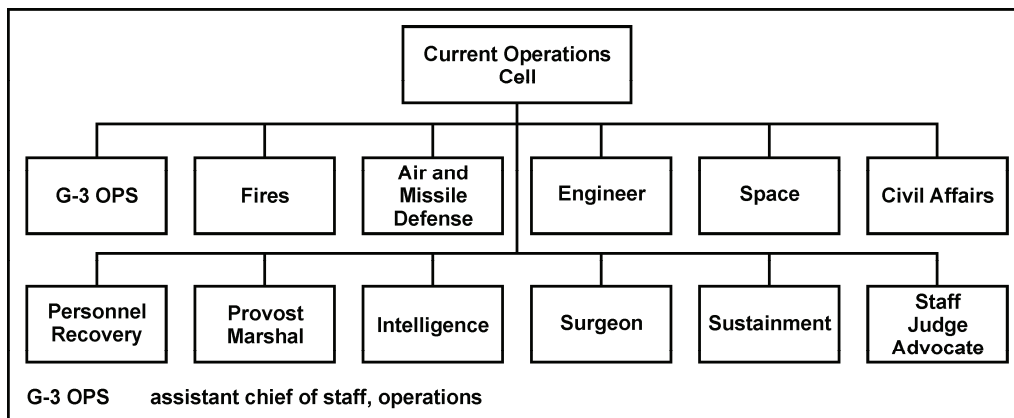

**Figure 4-6. Current operations cell at the main command post**

4-22. The chief of the current operations cell is the corps G-3 chief of operations (CHOPS). The corps G-3 supervises the CHOPS. The G-3 also synchronizes the activities of the future operations cell and the intelligence, fires, and protection functional cells even though those functional cells have their own chiefs—the G-2, fire support coordinator, and protection coordinator respectively.

## Future Operations Cell

- 4-23. Future operations is also an integrating cell found within the corps main CP that—
- Reviews for accuracy and completeness all messages and orders from the main CP for the TAC CP.
  - Conducts short- and mid-range planning for the current operation through the end of the current phase or a time designated by the commander.
  - Produces immediate fragmentary orders based on short- and mid-range planning followed by an operation order.
  - Maintains the status of all messages and orders in the main CP pertaining to short- and mid-range planning for current operations.
  - Modifies plans as required to support the current operations.
  - Tracks the status of all requests for forces.
  - Provides 24-hour planning capabilities.
  - Serves as the link between the future plans (G-5) and current operations integrating cells.
  - Oversees corps operational planning groups as required.
  - Chairs working groups that determine plan modifications that address opportunities or threats that impact the short- and mid-range planning of current operations.
  - Develops the commanding general decision support matrix for short- and mid-range planning of current operations.
  - Relays information to the plans cell that is required for further planning.

## Plans Cell

4-24. The plans cell is an integrating cell led by the G-5. It is responsible for the corps future plans. The plans cell contains several specialists including a School of Advanced Military Studies qualified planner, a strategic plans officer, a certified Joint Operation Planning and Execution System officer, and two non-commissioned officers. It also contains the functional area planners from the following specialties:

- Aviation.
- Electronic warfare.
- Engineers.
- Fires.
- Military deception.
- Military intelligence.
- Sustainment.

4-25. The plans cell oversees planning operations for the mid- to long-range time horizons. It develops plans for some corps branch operations and all sequel operations. It monitors the COP and stays abreast of the current operation by coordinating with the current operations cell. When sufficient time is available before execution and at the request of a TAC CP, the plans cell may write branches for the current operation. Plans cell members may use the joint operations planning process for developing operation plans and operation orders when the corps operates as a JTF or JFLC headquarters. Each staff officer represents a functional area during the planning process from receipt of the mission to orders production. (JP 5-0 discusses the joint operations planning process in detail. FM 6-0 discusses the military decision-making process.)

4-26. When planning requires functional area expertise that is not resident full time in plans, a plans working group meets, and an outside expert from the main CP is called to support the planning effort temporarily. The other coordinating, special, and personal staff sections in the main CP support the plans cell, as required, to include C2, protection, civil affairs, information engagement (IE), space, surgeon, PA, staff judge advocate, chaplain, and Air Force planners. When the corps serves in multinational and joint environments and conducts operations, planners from each nation and Service augments the plans cell.

**Main Command Post Personal Staff Sections**

4-27. The personal staff sections are located at the corps main CP. (See figure 4-7.) They deploy to the TAC CP as required. A short description of the functions of the operations research and systems analysis and Red Team elements follow since they are new organizations. FM 6-0 documents the functions of the public affairs officer, inspector general, chaplain, surgeon, and staff judge advocate.

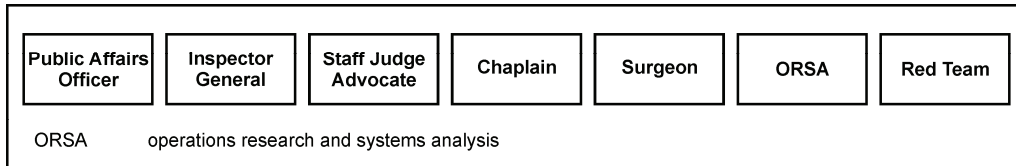

**Figure 4-7. Personal staff sections**

***Operations Research and Systems Analysis Section***

4-28. The operations research and systems analysis section uses scientific methods, such as mathematical modeling, statistics, and algorithms to improve the corps’ military decision-making process. This section aims to use science to elicit the best possible solutions to complex problems. The corps commander and COS direct activities of this section and interject it into the corps’ operations cycle as they deem necessary.

***Red Team***

4-29. The Red Team provides the commander with an independent enhanced capability to improve military planning and execution. It also provides the commander alternatives during planning and operations, such as challenging planning assumptions, assisting in problem and end state definition, identifying friendly and enemy vulnerabilities, and identifying assessment measures. Trained, educated, and practiced team members execute this function so commanders can independently explore alternatives. These alternatives are in plans, operations, concepts, organizations, and capabilities in the context of the operational environment. These alternatives also are from the standpoint of our multinational partners, our enemies and adversaries, and other perspectives. The Red Team will require augmentation by regional or functional experts based on the mission. Alternatively, the team’s members must be able to contact centers of excellence that contain the required information. It primarily participates in planning in the future operations and plans cells unless the commander integrates it into the intelligence cell. This team has a limited ability to monitor current operations simultaneously due to manpower constraints. It anticipates the cultural perception of partners, enemies, adversaries, and others and conducts independent critical reviews and analysis.

**Main Command Post Separate Coordinating Staff Sections**

4-30. Most coordinating staff officers in the corps are part of the warfighting functional cells. However, the G-7 and the G-9 are not assigned to any warfighting functional cells. The functions of the G-7 significantly differ from what FM 6-0 documents. Its functions are addressed below. See FM 6-0 for a detailed description of the duties of the other coordinating staff sections within the headquarters.

4-31. The assistant chief of staff, G-7 coordinates the corps IE activities. *Information engagement* is the integrated employment of public affairs, psychological operations, combat camera, and other means necessary to inform or influence enemy, adversary, neutral, and friendly audiences (FM 3-0). It includes the interaction of commanders and Soldiers with these audiences. Commanders use IE to build trust and confidence, communicate information, and promote support for Army operations. Information engagement can also counter the effects of enemy propaganda, misinformation, and rumors. By doing this, IE reduces confusion, fear, and apprehension among the local populace.

4-32. Public affairs is not an IE subordinate component. The public affairs officer is both a special and personal staff officer who retains direct access to the commander. PA activities, however, require close coordination and integration with IE. Hence, while the PA officer must plan and conduct public affairs activi-

ties; this officer also must coordinate and synchronize those activities in the IE working group under the purview of the G-7.

4-33. The G-7 chairs the IE working group and which performs three functions:

- Planning, preparing, supervising the execution, and assessing IE activities of PA, psychological operations, counterpropaganda, combat camera, military diplomacy, and defense support to public diplomacy in accordance with the commander's intent and guidance.
- Integrating IE activities with the division's employment of all other lethal and nonlethal means.
- Integrating IE engagement activities into division plans and orders.

These functions serve to inform and engage disparate audiences in the unit's AO. All functions aim to achieve an operational advantage that contributes to mission accomplishment. By the commander's intent and in its effects, IE is the operational and tactical application of strategic communications in a land AO.

4-34. G-7 responsibilities include producing materials to participate effectively in the operations process. These include the IE working group synchronization matrix, IE working group targeting and intelligence requirements, and the command engagement plan. The plan includes face-to-face engagements by the command group, staff, and subordinate commanders.

### Main Command Post Functional Cells

4-35. The main CP's functional cells are under the control of the corps chief of staff. FM 6-0 describes the functions of most of these personal staff elements. The staff provides the following functions:

- Advises the commander and staff elements on all matters pertaining to their areas of expertise.
- Assists the plans, future operations, and current operations integrating cells in preparing plans, orders, and their estimates in their areas of expertise.
- Makes recommendations to assist in reaching decisions and establishing policies.
- Manages information in their area of expertise.

### *Movement and Maneuver Cell*

4-36. The corps movement and maneuver cell provides the base around which the current operations and future operations cells form. The corps G-3 is the chief of the movement and maneuver cell. The functions of those two integrating cells were previously addressed. Other elements within this functional cell include airspace command and control, aviation, knowledge management (KM), political-military (POL-MIL), engineer, geospatial information and services, and space. (See figure 4-8.) A short description of the functions of the KM and POL-MIL elements follow.

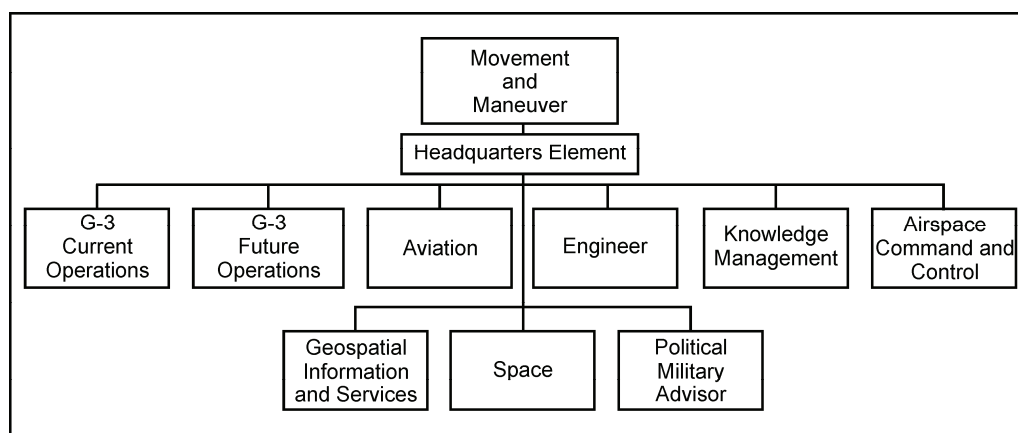

**Figure 4-8. Movement and maneuver cell at the main command post**

4-37. The KM element provides KM capabilities to the commander and staff through the integration and management of information and ABCS systems, optimized for situational understanding. The element coordinates with external knowledge sources and integrates them into the organizational knowledge network. The functions of this section include the following:

- Ensures KM processes are integrated into unit functions throughout the ARFORGEN phases.
- Enhances the commander's control capabilities through the management and integration of ABCS and other networks that optimize situational awareness throughout the command post. These other networks include the Joint Worldwide Intelligence Communications System, SECRET Internet Protocol Router Network, and Combined Enterprise Regional Information Exchange System.
- Builds and sustains a knowledge network architecture that enables the rapid sharing of tactics, techniques, and procedures; lessons learned; and explicit knowledge objects as well as connecting subject matter experts, and enabling life-long learning.
- Provides a set of information management processes that will create the competitive advantage and unity of effort for distributed decision makers that support the commander's critical information requirements and set conditions to accomplish a unit's mission.
- Understands the use of KM tools that maximize the availability of timely, relevant (current or historical), and usable information.
- Tailors the unit's KM plan to support command SOPs.
- Manipulates information into actionable products and formats that are readily understandable: getting the right knowledge to the right people at the right time.
- Provides the ability to analyze and integrate new and future information systems into the ABCS architecture.
- Provides in-depth knowledge and understanding of current and future operations in concert with the operational knowledge system architecture and systems architecture process and products to enable maximum information systems efficiency.
- Incorporates and manages a set of integrated applications, processes, and services that provides the capability for effective command post operations.
- Draws on the G-6 for network, database, and technical support.
- Trains unit staff on the effective use and applicability of the Battle Command Knowledge System.
- Aids the staff in battle board and battle update assessment management.
- Demonstrates knowledge of and extensive expertise in KM processes.

4-38. The POL-MIL element provides the commander cultural subject matter expert considerations to support current operations integrating center, future operations, or other staff elements or working groups. It integrates OGA activities and plans into corps operation plans and operation orders. This element also advises on enhancing regional alliances, coalitions, and security activities. It advises the commander and staff on interagency, multinational, and private volunteer organizations support requirements.

### ***Intelligence Cell***

4-39. The intelligence cell requests, receives, and analyzes information from all sources to produce and distribute intelligence products. The G-2 is the chief of the intelligence cell. The cell is built around what was previously the military intelligence battalion analysis and control element and includes the Air Force weather input. (See figure 4-9.) (The Air Force weather element is under OPCON of the Air Force air liaison officer.) It produces intelligence on the current operation to assist the commander and staff as they monitor progress and assess the operation. It also conducts continuous intelligence preparation of the battlefield (IPB) to support future operations planning and target development. The cell develops and tracks critical targets, performs all-source analysis, manages collection, and produces and maintains IPB products.



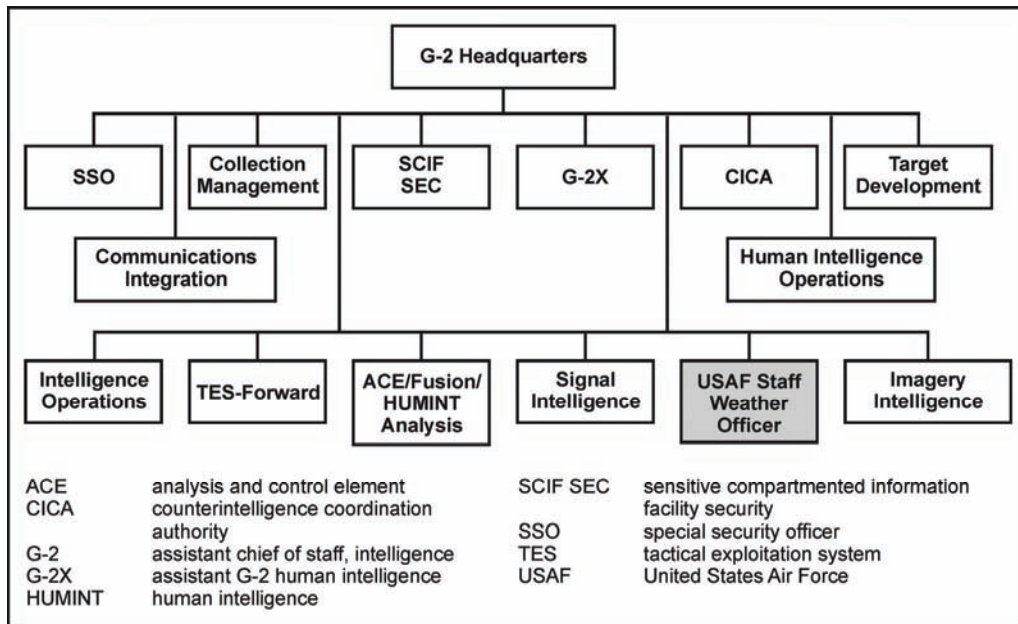

Figure 4-9. Intelligence cell at the main command post

*Fires Cell*

4-40. The fires cell consists of three elements: headquarters, fire support, and electronic warfare. (See figure 4-10.) The corps fire support coordinator is the chief of this cell. The fire support element coordinates Army and joint fires in support of the operation. It synchronizes Army and joint fires assets to support the commander's intent by the physical destruction of selected enemy combat capabilities. This element also selectively degrades or paralyzes an enemy's information systems through electronic warfare. This element requires the presence of joint personnel to adequately integrate joint capabilities into corps plans and orders. The electronic warfare element uses the same decide, detect, deliver, and assess methodology that the fire support element uses to integrate fire and maneuver. It also ensures that the employment of friendly electronic warfare systems does not degrade friendly C2.

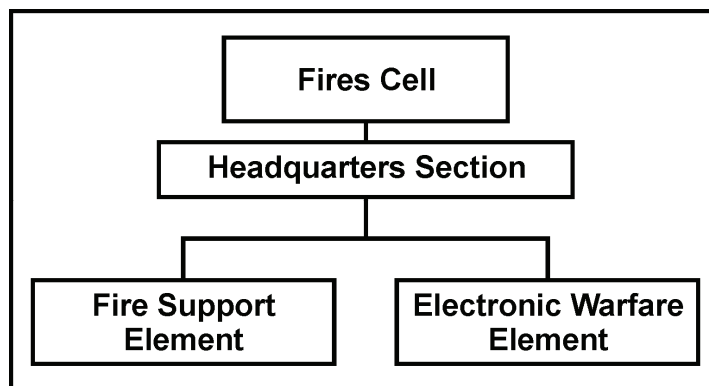
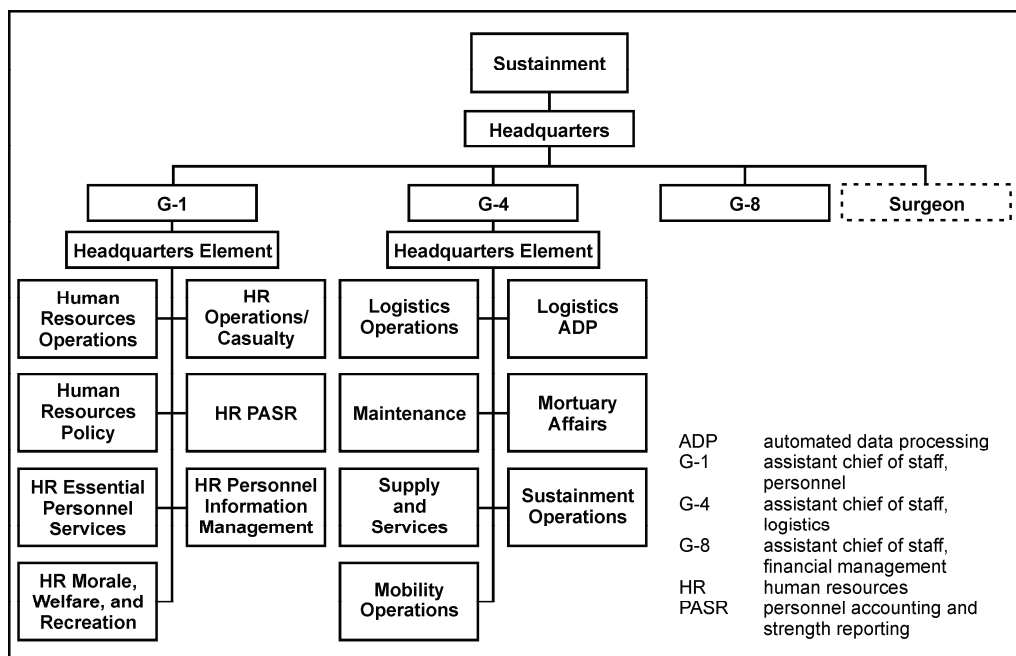

Figure 4-10. Corps main command post fires cell

**Sustainment Cell**

4-41. This cell consists of a small headquarters element and three coordinating staff sections—personnel administration (G-1), logistics (G-4), and resource management (G-8). (See figure 4-11.) The corps chief of sustainment is in charge of this cell. FM 6-0 addresses the functions of this cell's coordinating staff sections. A portion of the corps surgeon section co-locates with the sustainment cell.



**Figure 4-11. Sustainment cell**

**Command, Control, Communications, and Computer Operations Cell**

4-42. This cell is responsible for all corps command, control, communications, and computer operations (C4OPS) and information management matters. This includes network operations (NETOPS). NETOPS include network management, information dissemination management, and information assurance (IA). The corps G-6 is assisted by a NETOPS officer, IA staff manager, information management coordinator, and information system officer to assist in planning, preparing, executing, and assessing the corps' C4OPS. Figure 4-12 shows the internal organization of the C4OPS cell.

4-43. The C4OPS functional cell in the main CP—

- Prepares, maintains, and updates the C4OPS and information management operations estimates and portions of plans and orders that support the G-5.
- Recommends network priorities and locations for corps CPs.
- Ensures that redundant communications means are planned and available to pass time-sensitive critical information.
- Establishes automation systems administration procedures for all automation software and hardware employed by the corps.
- Conducts all IA activities within the command.
- Conducts the establishment of information network capabilities and services.
- Coordinates the availability of commercial information systems and services for military use.
- Manages bandwidth, radio frequency allocations and assignments, and provides spectrum management.

- Provides IA by—
  - Planning and executing information and system security functions.
  - Ensuring the appointment of an IA security officer in all elements of the force.
  - Planning, and executing communications security measures.
  - Providing IA direction and guidance to IA security coordinators.
- Develops the command information management plan to include establishing procedures for collecting, processing, displaying, storing, and disseminating data and information.
- Facilitates the staff presentation of relevant information according to quality criteria of accuracy, timeliness, usability, completeness, precision, and reliability to develop the COP.

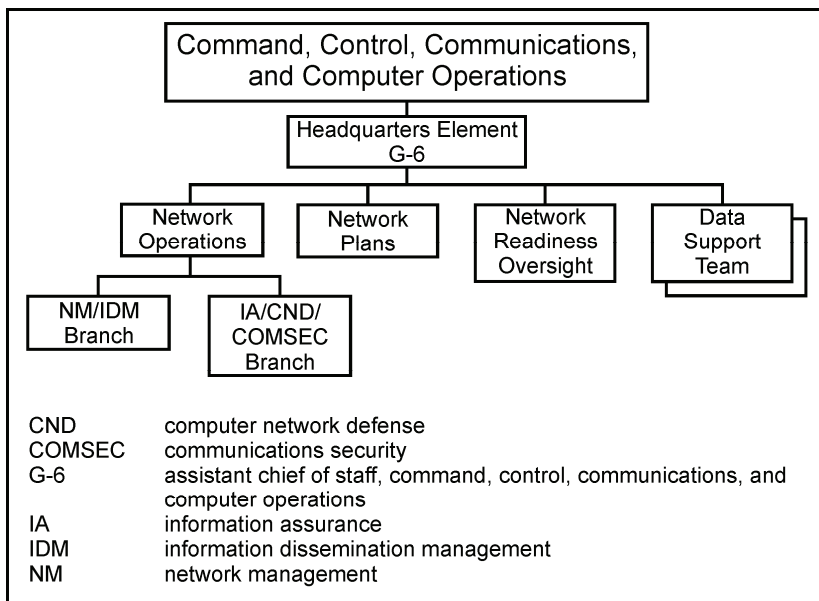

Figure 4-12. C4OPS cell in the corps main command post

### Protection Cell

4-44. This cell consists of the cell headquarters and six other elements—provost marshal; air and missile defense; engineer; personal recovery; operations security; and chemical, biological, radiological, nuclear, and high-yield explosives (CBRNE). (See figure 4-13.) The corps protection coordinator manages the cell's personnel and priorities while providing leadership to the cell. These elements represent a dedicated core staff. The staff focuses not only on their particular areas of expertise, but also in the integration and synchronization of the corps' overall protection efforts. This staff coordinates with—

- The movement and maneuver cell, especially with the maneuver planner.
- The fires cell, particularly the electronic warfare staff.
- The intelligence cell for assistance in the detection and refinement of hazards to the force and weather.
- The sustainment cell to ensure the correct protection-related supplies and equipment are on hand.
- The C4OPS cell to coordinate information, communications, and computer security.
- Separate coordinating and personal staff officers such as the G-9 and staff judge advocate.

Other staff elements are involved as necessary.

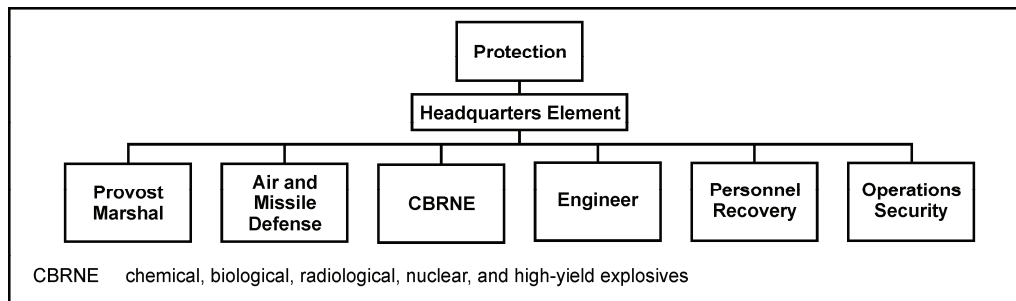

**Figure 4-13. Corps main command post protection cell**

4-45. The cell's duties include—

- Coordinating and integrating joint, interagency, and multinational protection support for corps units and installations.
- Providing protection functional expertise within the corps main CP.
- Providing advice and recommendations to the corps commander on the development of the corps essential elements of friendly information, defended asset list, and critical asset list.
- Running the corps protection working group.

4-46. While the corps G-6 actually does most of the work associated with the conduct of information protection, such as information assurance and computer network defense, the protection cell remains responsible for these areas. The cell allocates priorities and resources for protection in accordance with the commander's guidance. The corps surgeon typically has at least some preventative medicine personnel working closely with this cell. The protection cell often uses assets from the other warfighting functions to accomplish its mission.

### TACTICAL COMMAND POST

4-47. The corps TAC CP is organized as a current operations cell capable of 24-hours-a-day operations. (See figure 4-14.) The TAC CP requires access to the COP. It can control the corps operations for a limited time when the main CP is not available, such as when the main CP displaces. The deputy corps G-3, chief of operations, oversees its activities. It co-locates with the main CP when not controlling a specific subset of the corps overall operations. This enhances coordination between the two command posts. The TAC CP

maintains communications with the corps main CP; subordinates; higher headquarters; and appropriate joint, interagency, and multinational assets, entities, and authorities.

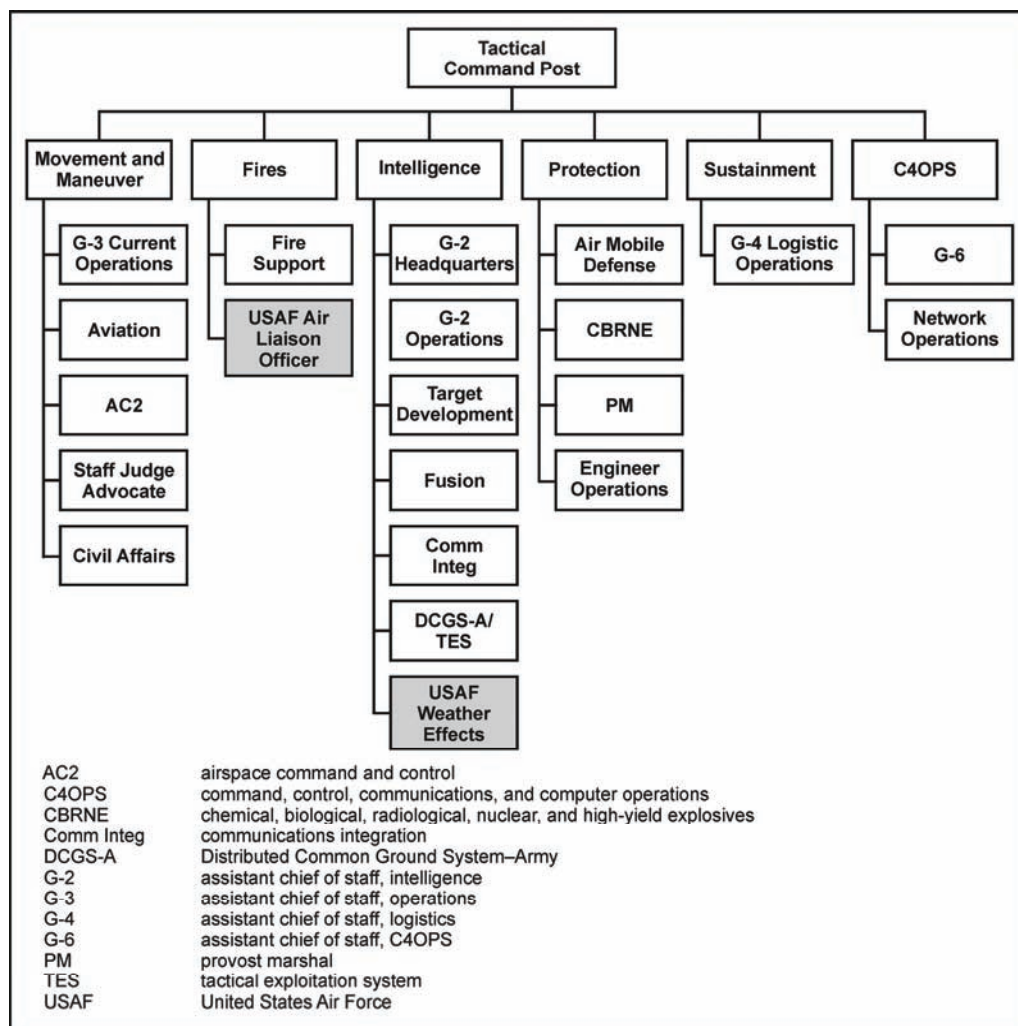

**Figure 4-14. Tactical command post functional cells and elements**

4-48. The TAC CP receives a task-organized support element consisting of communications and life support provided by the corps headquarters battalion. The corps headquarters battalion executive officer will lead the corps headquarters battalion support element for the TAC CP when the main CP and the TAC are not co-located.

4-49. The corps commander may use the TAC CP to control combinations of specific operations involving multiple subordinate units, such as river crossings; passage of lines; reception, staging, onward movement, and integration; and relief in place. Alternatively, it could be a CP for a special-purpose stability operations task force with subordinate units under its control. The corps commander could also use it to provide a staff for the deputy to control complex sustaining operation if that deputy becomes the corps support area commander or joint security area coordinator.

4-50. TAC CP employment options include the following:

- In a widespread offensive operation, the commander may designate the TAC CP to control operations of a portion of corps forces and act as a task force headquarters for a specific corps op-

eration, such as a river crossing, while the main CP controls the continuing operations of the corps subordinate divisions.

- When conducting noncontiguous operations, the commander may place the TAC CP in a forward but separate area from the area where the corps is conducting its decisive operations to conduct shaping or sustainment operations.
- The corps commander may distribute control of decisive and shaping operations between the TAC CP and main CP for complex operations. For example, the commander may allocate coordination of multiple beach assault and air assault operations throughout the corps' AO using the TAC CP while coordinating the timing and movement of envelopment forces for enemy destruction using the main CP.

### **EARLY ENTRY COMMAND POST**

4-51. The EECF is an ad hoc organization comprised of equipment and personnel from the staff of the TAC CP and the main CP. The TAC CP provides the base from which to add or subtract staff officers based on mission requirements to form the EECF. Commanders staff the EECF with a mix of current operations personnel and planners able to coordinate the reception of the corps and plan its initial operations. The corps standing operating procedures will designate those personnel from the main CP that will augment the TAC CP. The designation stems from standard anticipated missions modified based on the anticipated factors of METT-TC in projected AOs.

### **UNITED STATES AIR FORCE ELEMENTS**

4-52. The corps air liaison officer commands all Air Force personnel within the corps and is the air component commander's direct liaison to the corps commander. Air Force tactical air control parties (TACPs) are provided to Army maneuver unit headquarters from battalion through corps. TACPs advise the commander and staff on the capabilities, limitations, and employment of airpower. Each TACP is a primary point-of-contact to coordinate that echelon's preplanned and immediate air requests and to assist in coordinating air support missions. The corps main CP air liaison officer and TACP locate in or adjacent to the fires cell. Air Force personnel at the corps main CP provide planning expertise to integrate and use airpower. In the TACP, the air mobility liaison officer is the primary adviser on using airlift resources. This officer is trained to control airlift assets in support of ground troops and operate the airlift advance notification and coordination net. All Air Force personnel supporting the corps have a direct support relationship to the corps. Many of these personnel will come from the Air Support Operations Group aligned to support the corps. However some of these personnel may come from other Air Force organizations without having trained with the corps.

4-53. The air support operations center co-locates with the main CP when the senior fires cell is in the corps headquarters. The senior fires cell directs and monitors fires in the JOA. The air support operations center commander recommends the location based on the factors of METT-TC.

### **UNITED STATES MARINE CORPS INTEGRATION**

4-54. The corps will typically receive liaison from the Marine Corps when the corps is designated as a JTF or JFLC headquarters with an attached Marine air-ground task force. The personnel composition and equipment of these Marine Corps liaison elements will be determined by the Marine Corps. Marine Corps representatives operate as part of the current operations cell. However, Marines will also be found in the plans, fires, and airspace command and control cells and elements.

### **MULTINATIONAL INTEGRATION**

4-55. When designated as a multinational headquarters, the corps commander and chief of staff should ensure the maintenance of appropriate liaison with multinational elements operating in the JOA. This usually occurs through the mutual exchange of liaison teams. The corps determines the personnel and equipment composition of each corps liaison team according to the factors of METT-TC. Often then the corps must

provide additional personnel and equipment above that found in the liaison section of the TOE as part of its liaison teams. Placing multinational partner personnel in the cell and elements of the main and TAC CPs also depends on the factors of METT-TC. The amount of multinational personnel integrated into the corps headquarters and the duties they perform will vary according to the type of command structure established: lead country, coalition parallel, or alliance integrated.

## CORPS HEADQUARTERS BATTALION

4-56. The corps headquarters battalion task-organizes support elements to each CP. The corps headquarters battalion provides all administrative support, life support, communications, and transportation, and helps manage security for the corps CPs and MCG. The corps headquarters battalion is commanded by a lieutenant colonel with a complete battalion staff. The corps headquarters battalion contains four companies with distinct missions: headquarters and headquarters company, intelligence and sustainment headquarters company, signal operations company, and support company. The first two companies provide headquarters company support to the corps staff assigned to their respective organizations. The signal company provides network and communications support to the headquarters. The support company provides vehicle and generator maintenance to the corps three headquarters nodes. It also provides mess, medical, and transportation support to the main and TAC CPs. The support company contains the corps headquarters battalion staff. Any additional nonstandard companies, platoons, or teams supporting the corps headquarters, such as a security company or a band, are attached to the corps headquarters battalion for life support and security. (See figure 4-15.)

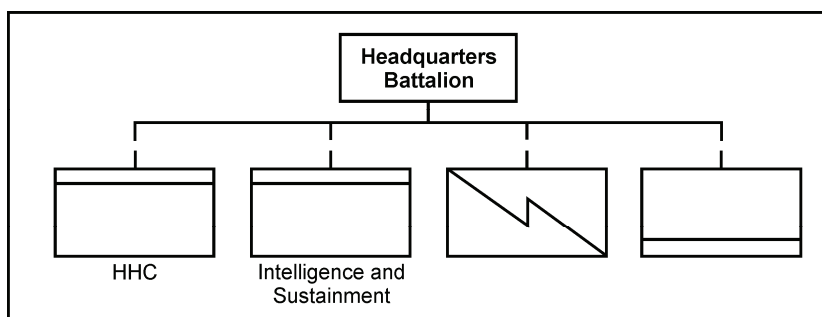

Figure 4-15. Corps headquarters battalion organization

## CORPS HEADQUARTERS AS A JTF HEADQUARTERS

4-57. When the corps headquarters is tasked to form a JTF headquarters, it is imperative that all staff sections and agencies have joint representation. The corps staff transitions to a joint staff structure to ensure unity of effort within the task force. However, only appropriate joint boards, centers, and cells should be established, not all possible doctrinal ones. Joint Service representation on the staff should be proportionate to the JTF's Service and multinational composition. Then Service components can fully participate in all staff processes.

4-58. The JTF establishing authority provides personnel and resources for the corps when the corps is a JTF. However, the corps commander, as the commander, joint task force, must determine what augmentation requirements the task at hand requires and coordinate support through the establishing authority. This augmentation is essential in the transition of the corps to a JTF structure. Joint Forces Command has documented a set of standard joint manning documents for standard scenarios.

4-59. The commander, joint task force must tailor staff augmentation for the specific situations. The following areas usually require augmentation:

- Joint and special staff sections.

- Specific functional area augmentation, such as a national intelligence support team, Defense Threat Reduction Agency support, Joint Information Operations Warfare Command, Joint Personnel Recovery Agency, and Defense Logistics Agency.
- Headquarters life support functions to accommodate the increase in the size of the headquarters. (This is usually provided through Army augmentation but other Service assets can provide it.)
- Communications support from the joint communications support element.

4-60. JP 3-33 addresses a discussion of joint staff directorates, and the specific boards, centers, and cells that the JTF may need to establish on a mission basis. JP 1 and JP 3-0 provide basic doctrinal guidance on JTF operations.

4-61. The corps headquarters, when designated as a JTF headquarters, will not also be the ARFOR headquarters. Therefore, it will not have administrative control responsibilities toward subordinate Army units located within the JOA of the JTF. A subordinate division headquarters should be assigned ARFOR responsibilities when the corps headquarters is designated as a JTF headquarters.

## **CORPS HEADQUARTERS AS A JFLC HEADQUARTERS**

4-62. The considerations outlined in chapter 3 for transforming the theater army operational command post into a JFLC headquarters also largely apply to transforming a corps headquarters into a JFLC headquarters.



## Chapter 5

# Division Headquarters Organization

This chapter describes the modular division headquarters organization. Divisions will command various types of brigade combat teams (BCTs) and supporting brigades. They operate a headquarters with task-organized subordinates instead of fixed formations with organic or assigned units. Any combination of brigade types will be task-organized to a division headquarters for a particular mission based on the factors of METT-TC. The historical designations of the division headquarters, such as the 1st Cavalry Division and 101st Airborne Division, do not necessarily reflect the capabilities of the division's attached BCTs. The division headquarters is designed to be able to operate as part of a joint force, command joint forces without initial Army augmentation, and command at the operational level of war. The headquarters includes organic signal capability. When not deployed, the division headquarters may be assigned responsibility for the training and readiness of specified brigade-size units.

### THE MODULAR DIVISION

5-1. The modular division is not a fixed organization as it was in square, triangular, Reorganization of Army Division, and Army of Excellence divisions. In addition to its attached BCTs, the modular division requires at least one of each of the five types of support brigades to have a fully effective combined arms team. (The sustainment brigade normally has a support relationship with the division's attached BCTs and supporting brigades. This same support, not command, relationship normally applies to the division headquarters.)

5-2. The division headquarters primarily uses assigned forces to establish specific military conditions in a specified area of operations (AO). No standard doctrinal size exists for a division AO. It varies according to the factors of METT-TC. For offensive and defensive tasks, the division conducts simultaneous and sequential battles and major operations. For stability tasks, the division combines effects over extended periods to control decisive points. In most operations, a single division conducts offense, defense, and stability tasks simultaneously, generating requirements for flexible command and control (C2) extending over great distances.

5-3. The division headquarters is a modular C2 organization. It can conduct full spectrum operations. The Army builds expeditionary force packages around the division headquarters. As the Army's primary warfighting headquarters, the division conducts decisive, shaping, and sustaining operations that translate operational-level goals into tactical action. The division is organized, manned, trained, and equipped to accomplish the following:

- Control a combination of up to six BCTs or combat aviation brigades (CABs) in major combat operations.
- Control a tailored mix of other warfighting capabilities organized under multifunctional brigades.
- Organize and distribute command and control assets according to the situation.
- Function as a joint task force (JTF) or joint force land component (JFLC) headquarters for small-scale operations with joint Service augmentation.
- Direct Army aviation in interdiction operations.
- Direct strike operations.
- Control battalion- to brigade-sized air assaults.

## Division Headquarters Organization

---

- Establish temporary bases along a line of operations or in an AO.

5-4. Divisions can simultaneously C2 up to six BCTs and CABs engaged in major combat operations but may control more maneuver brigades during the conduct of protracted stability operations. They may also control more BCTs when the BCTs cycle through mission staging with fewer than six maneuver brigades conducting simultaneous combat operations. The division may employ any mix of heavy, infantry, or Stryker BCTs. This span of command may need to decrease during forcible entry operations. Each division's task organization differs, not only for a particular campaign, but also for different phases of the campaign. The higher headquarters task-organizes the division according to the factors of METT-TC.

5-5. Normally, the division will be under the operational control (OPCON) of a JFLC, an ARFOR, or a corps headquarters for major combat operations. For small-scale operations, it may be a JFLC or ARFOR OPCON to a JTF.

5-6. The division headquarters controls battles and engagements through its subordinates. For example, it gives mission orders to its attached combat aviation and fires brigades to conduct interdiction and strike operations instead of directly controlling the operations of these brigades. (The division remains responsible for airspace management in its AO.) It controls battalion- to brigade-sized air assaults using aviation elements under its OPCON. However, the division does not conduct or control simultaneous airborne operations and battalion-sized air assault operations.

5-7. In addition to BCTs, the division uses mission orders to direct the execution of the other warfighting functions organized under multifunctional brigades. These include the fires brigade, the maneuver enhancement brigade (MEB), and the battlefield surveillance brigade. One or more sustainment brigades assigned to the theater sustainment command as well as other forces support the division to establish temporary bases along a line of operations or in an AO. The division employs available BCTs and MEBs to provide area security for these bases. The factors of METT-TC determine the mix of forces assigned to the support brigades.

5-8. Division commanders organize and distribute their control systems according to the existing or projected factors of METT-TC and their command styles. These command posts (CPs) are control nodes for information flow and planning. Their information systems, staffs, and the common operational picture (COP) enhance the commander's ability to visualize possibilities and recognize opportunities. Many information systems are not restricted by line-of-sight considerations. Division commanders may assign these control nodes to geographically dispersed operations. They may also allocate nodes to control divergent types of simultaneous operations (offensive and stability operations), by major operational function (maneuver versus sustainment operations), or according to purpose (decisive, shaping, and sustaining). Division commanders co-locate the main and tactical CPs during the conduct of operational themes other than major combat operations. There are several reasons to co-locate. The operational tempo is somewhat slower, operations are conducted over an extended time, less tolerance for errors exists that requires a greater degree of synchronization, and there is less risk that a single attack will destroy the co-located headquarters than during major combat operations.

5-9. Division commanders must establish a physical presence to best exercise command. They must maintain a sense of how the operation is unfolding regardless of the CP configurations and their assigned missions. Sometimes, this is at a CP; at other times, it is with the Soldiers they lead. Division commanders move as necessary using the mobile command group to maintain necessary connectivity with the division's command and control system.

## DIVISION COMMAND POSTS

5-10. The commander determines the sequence of deployment, timing of moves, initial locations, and task organization for CPs based on the factors of METT-TC and the commander's visualization. The commander task-organizes functional capabilities and personnel across the CPs to fit their concept for C2 for the operation. The division has a mobile command group (MCG), a main CP, and a tactical command post (TAC CP). They provide the division commander flexibility in arranging CPs in the area of operations. This flexible CP structure allows the division commander to exert command presence where desired. The fac-

tors of METT-TC may dictate the co-location or consolidation of the CPs or the creation of a CP tailored from these assets, such as an early entry command post. Each CP performs specific functions by design as well as additional tasks assigned by the commander. In the division operations order C2 paragraph (paragraph 5), the commander details changes to the authority, responsibilities, and task organization of the division CPs from division echelon doctrinal responsibilities and designed functions as well as any special instructions.

5-11. When deployed, the division headquarters is organized around three C2 nodes. Organic signal, transportation, life support, and a security force complete the structure of the division. Figure 5-1 illustrates the function of the three elements. The design of the division's C2 elements gives the division commander various options for using the headquarters. The TAC CP provides flexibility for training, readiness, and operations. The MCG is equipped to permit the division commander to reach any point in the division AO by ground or air and remain linked to the rest of the headquarters and to the COP. The main CP can locate anywhere in the AO or designated sanctuary locations, while remaining linked with the current operations of its subordinate brigades and performing the full range of C2 functions. The C2 functions include developing plans, conducting analysis, providing detailed estimates, issuing operation orders (OPORDs) and fragmentary orders (FRAGOs), and controlling current operations.

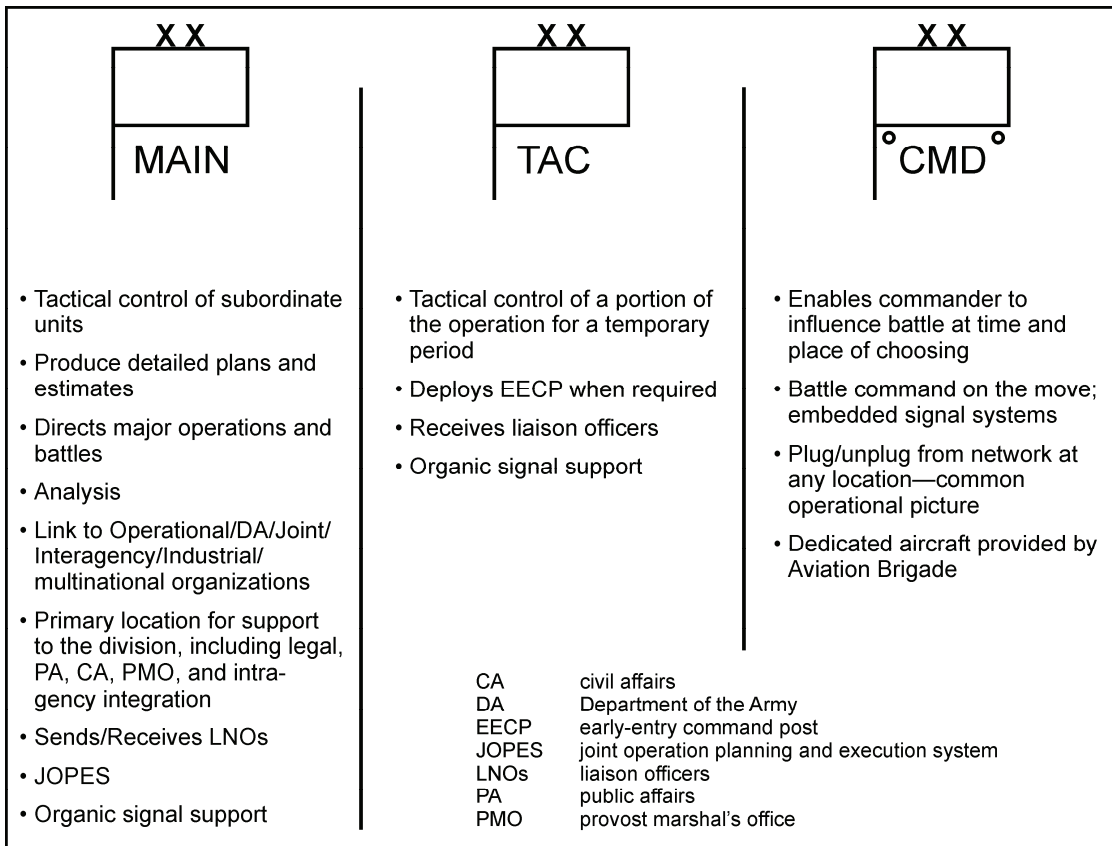

Figure 5-1. Division command and control nodes

**MOBILE COMMAND GROUP**

5-12. The MCG serves at the commanding general's personal CP. Its mobility allows the division commander to move to the point of decision. The commanding general can get in position to assess the risks and make adjustment decisions by seeing, hearing, and understanding what is occurring. What is learned and seen helps the commander mentally visualize adjustments needed in current and future operations while

## Division Headquarters Organization

---

moving about the AO and interacting with subordinate commanders and different staffs. Thus the MCG allows the commanding general to command from anywhere in the AO and not become tied to the TAC or main CP. The MCG has both a ground and an aerial component. The MCG allows the commander to—

- Provide personal leadership, commander's intent, and guidance at the critical place.
- Make a personal assessment of the situation.
- Maintain situational understanding while moving around the AO by allowing the commander continuous access to updated information.
- Travel with key staff officers necessary to provide information relevant to the current operation.

5-13. The MCG ground component consists of four armored HMMWVs, each with multifunctional display units—Army Battle Command Systems (ABCSs)—that provide a command on the move capability. The only personnel permanently assigned to the MCG on the table of organization and equipment (TOE) are the four vehicle drivers.

5-14. The air component of the MCG consists of Army Airborne Command and Control System (A2C2S) equipped UH-60A/L helicopters assigned to a CAB and provided when required. The A2C2S is a console capable of simultaneously receiving, processing, and displaying information configured to the commander's and staff's needs. Data links for connectivity to many ground and air platforms provide the commander with the flexibility to operate across the spectrum of conflict without additional equipment.

5-15. Ground and air components each have a communications capability to monitor the command, higher command, and the operations and intelligence nets. The signal company organic to the division headquarters battalion provides this communications capability. While the MCG takes advantage of its small signature, speed, and mobility; it requires the presence of a tailored security force. While the TOE of the division headquarters battalion contains a security company, that company has not been resourced. The division must task a subordinate unit to provide a security force to the division headquarters battalion, which will task-organize security elements to secure the MCG and division CPs.

5-16. The staff officers in the MCG consist of subordinate staff officers able to operate the ABCS multifunctional display units rather than primary staff officers. The division commander chooses the individual staff officers that staff the MCG based on the factors of METT-TC. MCG personnel often represent those staff sections that can immediately affect current operations. These sections include maneuver, fires, and intelligence in addition to the air liaison officer (ALO), and when needed, a joint terminal attack controller. The mission and staff available, however, dictate its makeup. For example, during a deliberate breach, the division commander may include an engineer staff officer. When visiting a dislocated civilian collection point, the commander may replace the fires element staff officer and ALO with a translator or medical officer.

## MAIN COMMAND POST

5-17. The main CP is the division's principal command post. It provides the commander with a full suite of information systems to plan, prepare, execute, and assess division operations. The staff at the main CP operates under the supervision of the division chief of staff (COS). The main CP performs the following functions:

- Controls all division operations.
- Serves as the primary plans, analysis, and sustainment coordination CP.
- Monitors and assesses operations for impact on future operations.
- Conducts planning for major operations and battles.
- Writes operation plans (OPLANs).
- Writes branch plans as requested by the G-3 (or G-5 if done in the plans integrating cell).
- Integrates intelligence activities into both current and future operations.
- Produces multisource intelligence products.
- Produces terrain products.
- Conducts information management.

- Coordinates and manages force structure to include request for forces and equipment.
- Synchronizes the division’s targeting process.
- Coordinates civil affairs activities in the AO.
- Prepares and maintains division running estimates, plans, and orders to support future operations.
- Assesses sustainment operations.
- Prepares all reports required by higher headquarters.

5-18. The main CP is functionally organized into a mix of warfighting function and integrating cells to facilitate staff communications and interaction. FMI 5-0.1 discusses the concept of integrating and functional cells based on warfighting functions (less the command, control, communications, and computer operations [C4OPS] cell). Figure 5-2 illustrates a way the division main CP could organize using standard field shelters. (The division main CP will usually take advantage of available buildings to increase the amount of protection afforded to its personnel and electronic systems.)

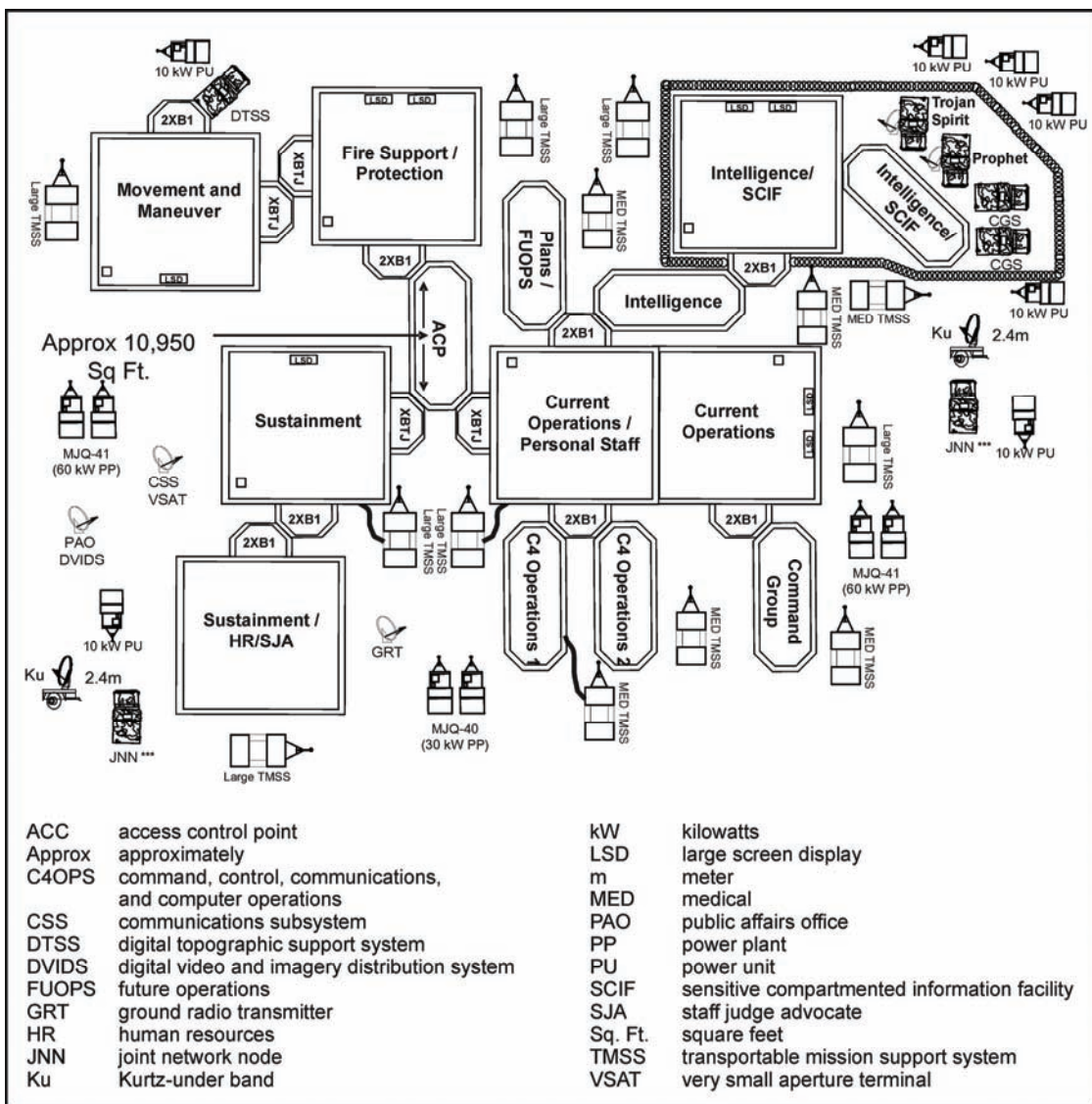

Figure 5-2. Example layout of the division main command post

## Division Headquarters Organization

---

5-19. Normally, the main CP—less any individuals and equipment needed to augment the TAC CP to form the early entry command post—remains at home station during the initial phases of deployment process. Once the early entry command post is established in the joint operations area (JOA) of the gaining joint force commander (JFC), the commander can deploy the main CP into the JOA. Normally the main CP deploys in at least two echelons.

5-20. The main CP lacks the organic equipment to conduct C2 on the move, so it must operate in a stationary mode. The main CP is 50 percent mobile and requires two lifts to displace with organic transportation assets. The satellite communications-based, networked communications capabilities organic to the division headquarters battalion significantly reduces the need to displace the main CP frequently to maintain control of subordinate brigades. The main CP can be organized into many different configurations to match its available TOE, commercial field shelters, or existing buildings. The main CP may occupy a location in a given configuration on either a temporary or a long-term basis.

5-21. The primary considerations in positioning the main CP are communications, survivability, and accessibility. Support assets task-organized from the division headquarters battalion co-locate with the main CP. When the division conducts operations against an enemy with the capability to attack the main CP, it disperses and camouflages its organic tactical vehicles and communications equipment. Such actions reduce their electronic and visual signature to enemy reconnaissance and surveillance assets. The main CP also considers other security measures appropriate to the environment.

5-22. The commander determines where to locate the main CP. The division headquarters battalion commander—in coordination with the division COS, G-2, G-3, and G-6—recommends general locations from which the commander may pick. Locations should also be close to a fixed-wing air base and contain a helicopter landing zone. The main CP can co-locate with one of the division's subordinate brigades, usually a MEB or a CAB if they are assigned to the division. The division headquarters battalion commander assigns specific locations to each staff cell and division headquarters battalion elements within the selected site.

### MAIN COMMAND POST CELLS, ELEMENTS, AND SECTIONS

5-23. Figure 5-3 shows that the main CP is organized on the TOE into the following cells and elements:

- Headquarters element.
- Personal staff sections.
- Separate coordinating staff sections.
- Plans cell (integrating cell).
- Current operations cell (integrating cell).
- Future operations cell (integrating cell).
- Movement and maneuver cell (functional cell).
- Intelligence cell (functional cell).
- Fires cell (functional cell).
- Sustainment cell (functional cell).
- Protection cell (functional cell).
- C4OPS cell.

These staff cells and elements operate under the general supervision of the COS.

5-24. The main CP's elements are organized into cells with the exception of the personal staff and the G-7 and G-9 coordinating staff sections. These cells can be either functional or integrating cells. The cells are scalable to accommodate joint staff augmentation when required, such as when the division is a JFLC or JTF.

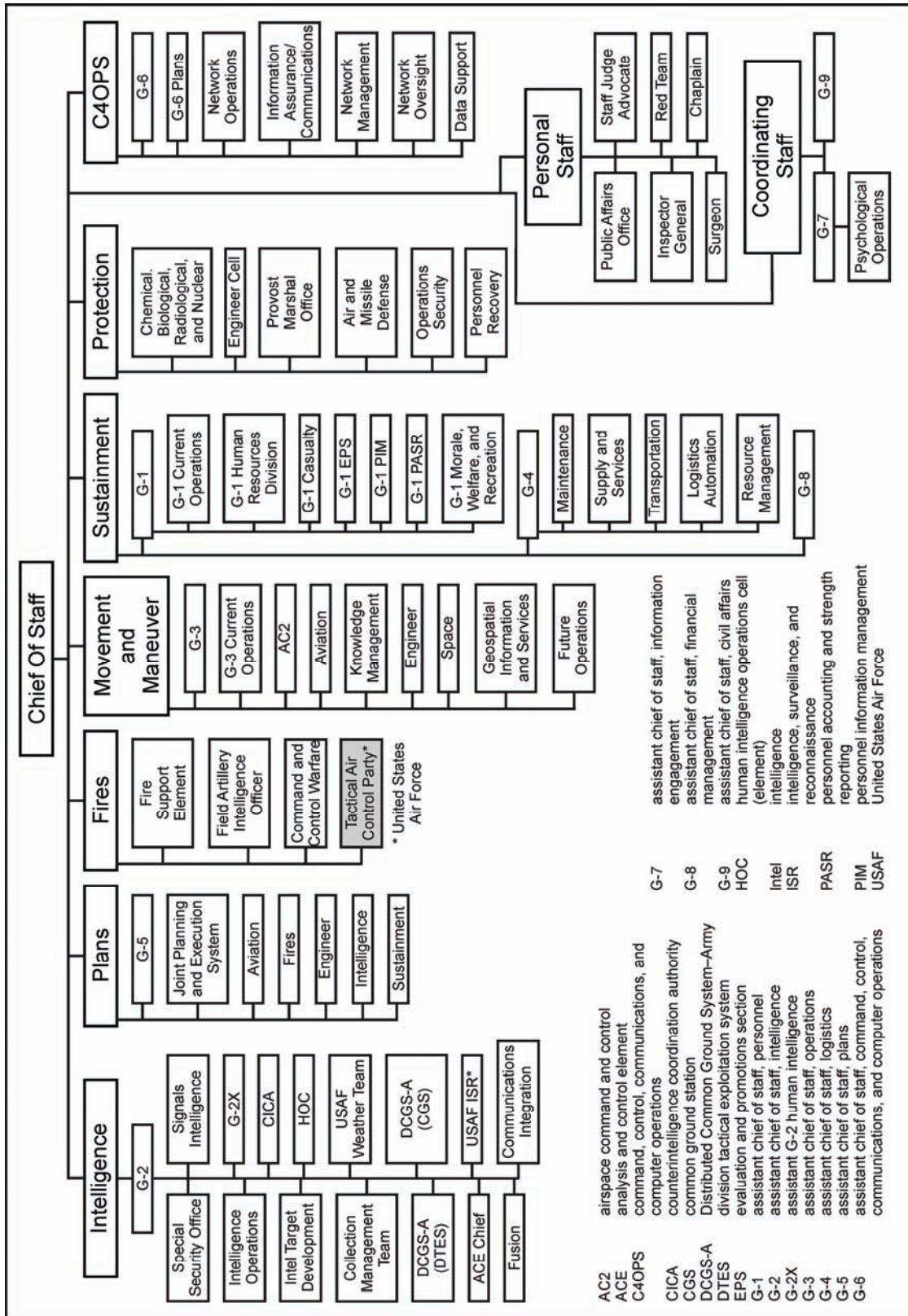

Figure 5-3. Organizing main command post by integrating functional cells and other elements

### Headquarters Element

5-25. The headquarters element provides administrative support for the division commander, serves as the focal point for liaison, and orchestrates a synchronized staff effort. The headquarters element consists of the COS, the secretary of the general staff (SGS), organic liaison officers (LNOs), and supporting personnel. The COS works as the commander's principal assistant for supervising and training the staff. The commander normally delegates authority to the COS to manage the staff. The COS frees the commander from routine details and passes pertinent information and insight from the staff to the commander and from the commander to the staff.

5-26. The SGS assists the COS by planning and supervising special conferences and meetings, directing preparation, and monitoring execution of itineraries for distinguished visitors to the headquarters. It also acts as the informal point of contact for LNOs.

5-27. Receiving and dispatching liaison teams are critical functions of the headquarters element. LNOs provide and disseminate relevant information and represent adjacent, attached, OPCON, supporting, and, in some cases, supported units, at the main CP. The division commander and chief of staff prioritize when the number of LNOs required by the division exceeds the number of LNO assets organic to the division. Commanders must take division staff officers from lower priority tasks and divert them to this task or task subordinate units to provide the required personnel and equipment.

5-28. The division may also be augmented with LNOs from other government agencies, nongovernmental organizations, international organizations, and joint or multinational headquarters. These LNOs are located in CPs, cells, or the division civil affairs operations center as necessary, to best facilitate operations.

### Personal Staff

5-29. Figure 5-4 shows the personal staff sections located in the main CP. FM 6-0 discusses the functions of the public affairs officer, inspector general, chaplain, surgeon, and staff judge advocate. The functions of the operations research and systems analysis and Red Team sections at the division are the same as those discussed in chapter 4 for the corps.

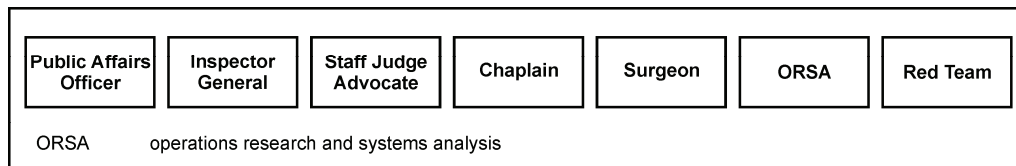

**Figure 5-4. Personal staff sections**

### Coordinating Staff

5-30. Coordinating staff sections coordinate actions for the commander and for the special staff section over which they are assigned coordinating staff responsibility. Coordinating staff responsibility includes—

- Ensuring that the special staff officers or elements for which they manage have sufficient, personnel, equipment, sustainment, and facilities to perform their duties.
- Coordinating actions and tasking of special staff officers across the entire staff.
- Informing the COS of the special staff officer's actions.

The G-7 and G-9 are not integral parts of any of the division headquarters functional cells. The division G-7's specific functions mirror those described for the corps headquarters in chapter 4. See FM 6-0 for a detailed description of duties of the other coordinating staff sections in the headquarters.



**Integrating Cells**

5-31. The integrating cells operate across the warfighting functions located in the main CP. The three integrating cells consist of individuals and elements from the functional cells. They focus on integrating plans and operations across division structure. The three integrating cells are the current operations cell, the future operations cell, and the plans cell. See FMI 5-0.1 for a detailed description of the hand-off of plans through the three integrating cells.

**Current Operations Cell**

5-32. This integrating cell is composed of representatives from all functional cells less C4OPS and most personal staff sections. (See figure 5-5.) The current operations cell controls operations, monitors the current operation status, and updates the staff at the main. From here, the COS supervises current operations and directs the actions of the main CP.

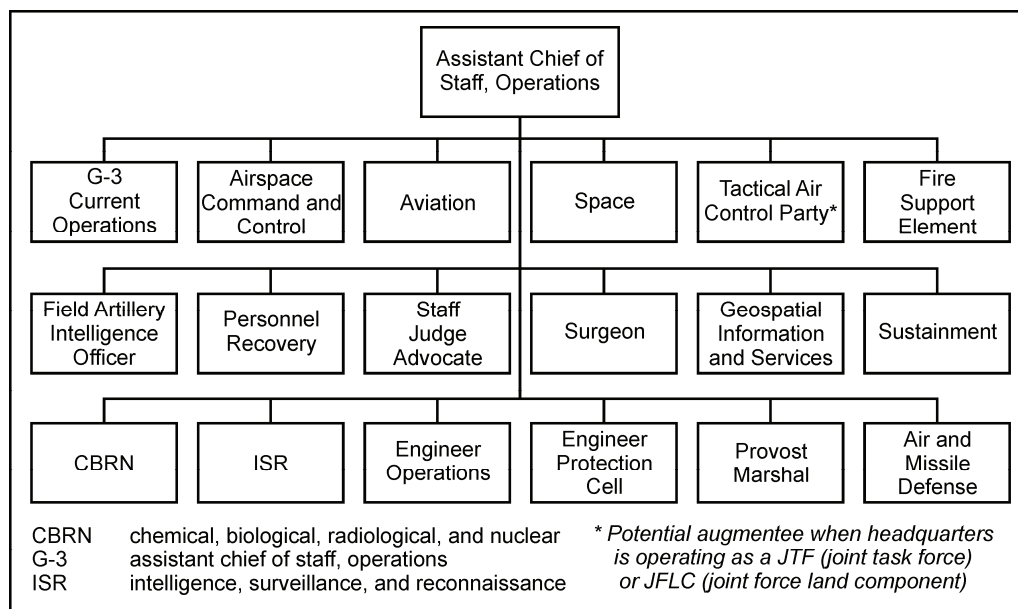

**Figure 5-5. Main command post current operations cell**

5-33. The G-3 operations element forms the nucleus of the current operations cell. The G-3 operations officer has responsibility for the overall function of the current operations element. The COS assigns tasks to other main CP cells and elements for their inputs and contributions necessary for the current operations cell to accomplish its functions. The G-3 operations element—

- Controls tactical operations.
- Monitors the tactical situation to include the status of friendly forces.
- Maintains information about the current status of the division.
- Maintains communication with the TAC CP; MCG; and subordinate, adjacent, and higher headquarters.
- Provides current situation information to other CP cells and staff sections and to higher, lower, supporting, supported, and adjacent units to include receiving and acting on all incoming messages, orders, requests for information, and taskings.

**Future Operations Cell**

5-34. This cell, also under the G-3, develops FRAGOs for mid-range time horizons, monitors current operations, and develops branch plans to the current OPORD. Although austere, the base future operations

## Division Headquarters Organization

---

cell can receive augmentation from other cells, elements, and staff sections. When necessary the future operations cell can assist the current operations cell in developing short-range FRAGOs. The cell's functions include—

- Reviewing all messages and orders from the main CP for accuracy and completeness.
- Conducting short- and mid-range planning for the current operation through the end of the current phase or a time designated by the commander.
- Producing a FRAGO or message based on short- or mid-range planning followed by the OPORD.
- Modifying plans to support current operations.
- Maintaining the status of all messages and orders in the main CP pertaining to short- and mid-range planning for current operations.
- Tracking the status of all requests for forces actions.
- Providing 24-hour planning capabilities.
- Serving as the link between the future plans (G-5) and current operations integrating cells.
- Overseeing division operational planning groups as required.
- Chairing working groups that determine plan modifications that address opportunities or threats at the short- and mid-range planning periods of current operations.
- Participating in the division's targeting process.
- Developing the decision support matrix for short- and mid-range planning of current operations.
- Relaying information to the plans cell that it needs for further planning.

### *Plans Cell*

5-35. The G-5 leads the plans cell and oversees planning all future operations. The G-5 leads the plans element. It contains several specialists including a School of Advanced Military Studies qualified planner, a strategic plans officer, a Joint Operation Planning and Execution System (JOPES) officer, and two NCOs. It also contains the full-time functional area planners indicated in figure 5-6. Other individuals from the functional cells augment these functional planners as required.

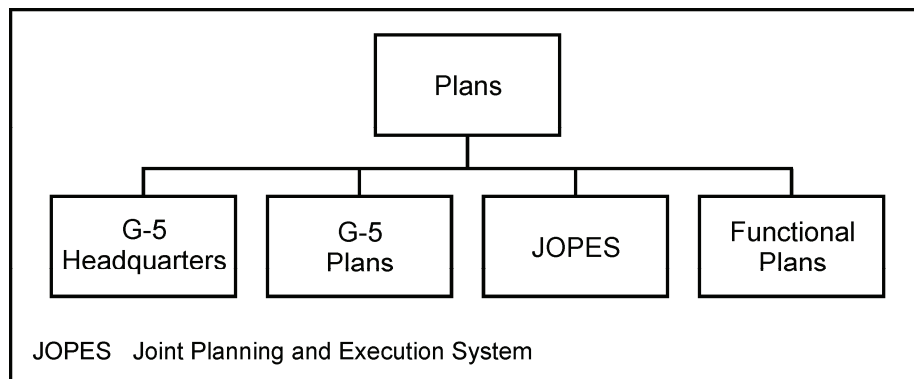

**Figure 5-6. Main command post plans cell**

5-36. The plans cell has responsibility for planning in the mid- to long-range time horizons. It develops plans, orders, branches, and sequels. It monitors the COP and stays abreast of the current operation by coordinating with the current operations cell. When sufficient time exists before execution and the G-3 directs, the plans cell may write branches for the current operation, particularly if those branch plans and FRAGOs are relatively complex. Plans cell members use the military decision-making process (MDMP) for developing OPLANs and OPORDs. Staff officers represent their functional areas during the MDMP. (FM 5-0 details the MDMP.) The plans cell—

- Conducts planning for major operations and battles.
- Produces OPLANs, OPORDs, and warning orders to transition to future operations.
- Coordinates closely with the current operations cell to transition from current to future operations.
- Participates in the targeting process.
- Completes a long-range assessment of an operation's progress.
- Conducts operational planning to include supporting plans to the JFC when an ARFOR or JFLC.
- Conducts military deception planning for the division.
- Manages JOPES to include input and review of the time-phased force and deployment data and the process to request for forces.
- Coordinates and manages force structure to include requests for forces and equipment.

5-37. The plans cell plans operations to be conducted in the next phase of the operation occurring in the unit's contingency or orientation time horizon. However, the commander may task the plans cell to plan operations in the current phase or near-term time horizon.

5-38. When planning requires expertise not in the plans cell, a plans working group meets and an outside expert from the main CP is tasked to support the planning effort temporarily. One full-time planner takes charge of the working group. The other coordinating, special, and personal staff sections in the main CP support the plans cell, as required. The plans cell may be augmented with joint and multinational planners when the division serves as a JTF or combined joint force land component.

### **Warfighting Functional Cells**

5-39. The main CP contains the following six functional cells:

- Movement and maneuver.
- Intelligence.
- Fires.
- Sustainment.
- C4OPS. (The C4OPS cell differs from the command and control warfighting function in that the warfighting function is broader and includes the commander as well as the C2 system.)
- Protection.

#### ***Movement and Maneuver Cell***

5-40. The movement and maneuver cell is led by the G-3 and consists of the following elements: G-3 current and future operations, airspace command and control, aviation, civil affairs, engineer, space, geospatial information and services, and political-military advisor. (See figure 5-7 on page 5-12.) The movement and maneuver cell provides information on the current status of the division to all staff members at the main CP. In this cell, the staff exchanges information and coordinates activities.

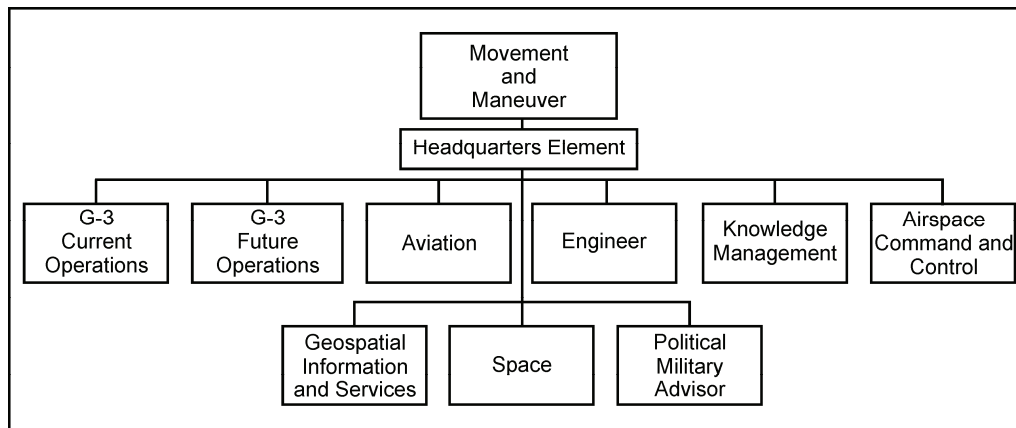

**Figure 5-7. Main command post movement and maneuver cell**

5-41. From the movement and maneuver cell, the G-3 supervises the conduct of current and future operations. The cell also—

- Synchronizes the execution of division operations.
- Maintains a friendly situation.
- Modifies current operations by directing the implementation of the commander's adjustment decisions, usually by using FRAGOs.
- Recommends adjustments to the current operation including commitment of the division reserve and tactical combat force.
- Manages terrain in the division AO.
- Executes contingency planning.
- Directs division shaping operations.

### ***Intelligence Cell***

5-42. The intelligence cell requests, receives, and analyzes information from all sources to produce and distribute combat intelligence. The cell is built around the G-2 staff section and what was previously the Army of Excellence military intelligence battalion analysis and control element. It is supported by a United States Air Force (USAF) battlefield weather element and, when assigned, a USAF intelligence element. (See figure 5-8.) (Both Air Force elements are OPCON to the USAF air liaison officer supporting the division.) The intelligence cell conducts continuous intelligence preparation of the battlefield (IPB) to support future operations planning and target development. This cell develops and tracks critical targets, performs all-source analysis, manages collection, and produces and maintains IPB products.

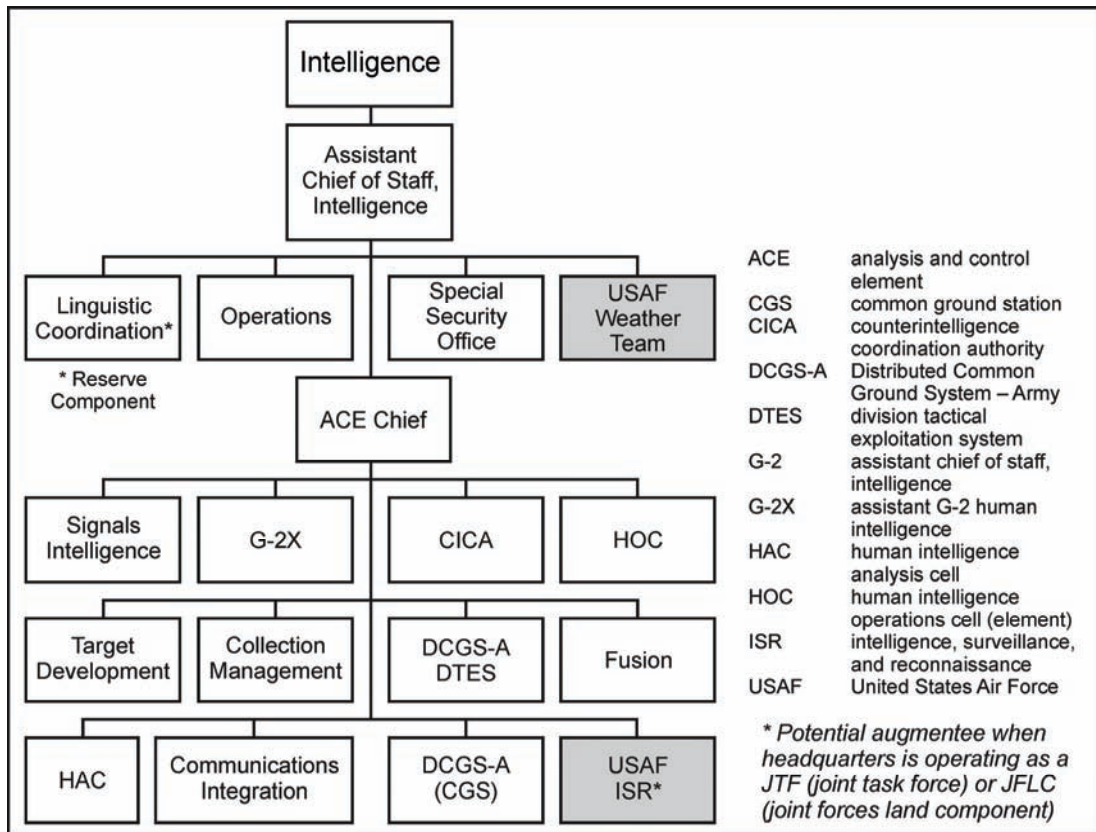

Figure 5-8. Main command post intelligence cell

**Fires Cell**

5-43. The fires cell coordinates joint and multinational lethal and nonlethal fires to achieve the effects necessary to meet the commander’s intent. (See figure 5-9 on page 5-14.) The fires cell monitors, directs, and adjusts the division fires plan and synchronizes the division targeting process. The cell integrates fires with the other warfighting functions into the decide, detect, deliver, and assess (D3A) phases of targeting, and assists the G-3 synchronize this effort with the overall concept of operations. Throughout D3A, this cell relies on numerous staff elements to ensure a synchronized targeting and fires effort. These elements can include the command and control warfare officer, air liaison officer, and the airspace command and control element. The concept of operations translates commander’s intent into tasks to subordinate units and parameters for automated systems in support of division operations. It completes mission planning analysis, develops a course of action (COA), coordinates production of running estimates, produces the fires plan, and produces the fires estimate and annex. It and other members of the targeting team analyzes enemy COAs and identifies basic high-value targets at the same time. It does not produce division OPLANs or OPORDs. Rather, the fires cell provides input to the division’s three integrating cells and incorporates its products into the coordinated OPLANs and OPORDs produced by G-5 and G-3. As the staff wargames friendly COAs, the targeting team develops initial proposals on high-payoff targets and attack guidance. After the commander selects the final COA and issues further guidance, the targeting team refines and prioritizes the high-payoff target list and develops the attack guidance matrix.

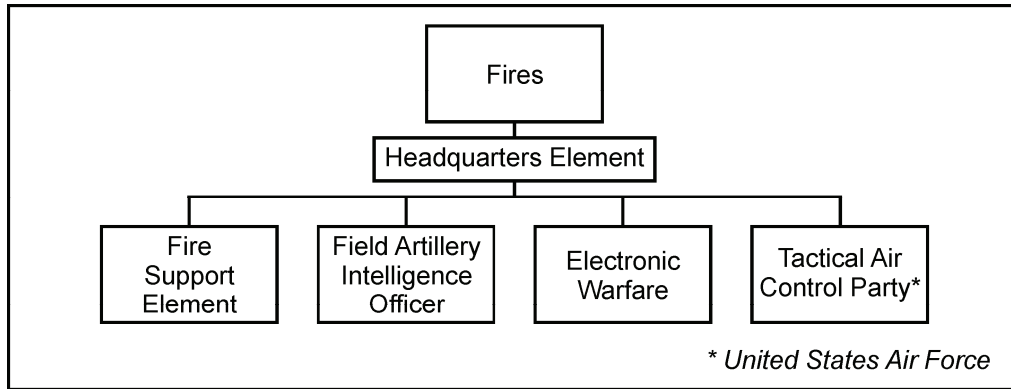

Figure 5-9. Main command post fires cell

**Sustainment Cell**

5-44. The sustainment cell consists of representatives from several sustainment areas. (See figure 5-10.) The G-4 is dual-hatted as the chief of this functional cell. The sustainment cell provides personnel to support the integration cells as well as managing the day-to-day logistics integration for the division and its supported units. It serves as the primary link between the division staff and the supporting sustainment brigade. The cell provides logistics management and in-transit visibility for the command. The majority of the division surgeon section also co-locates with this cell.

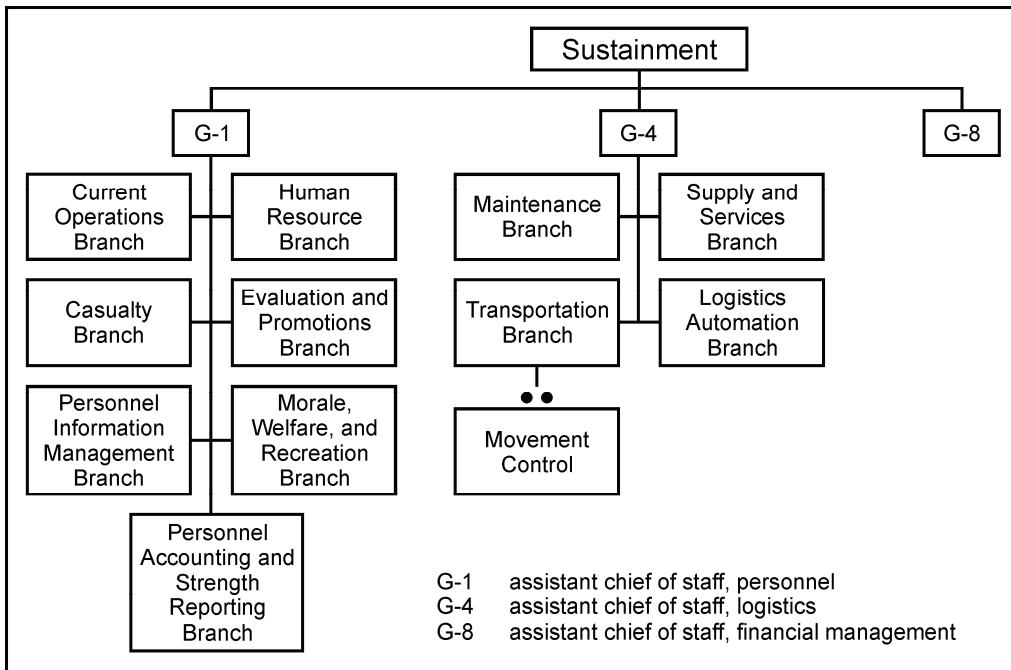
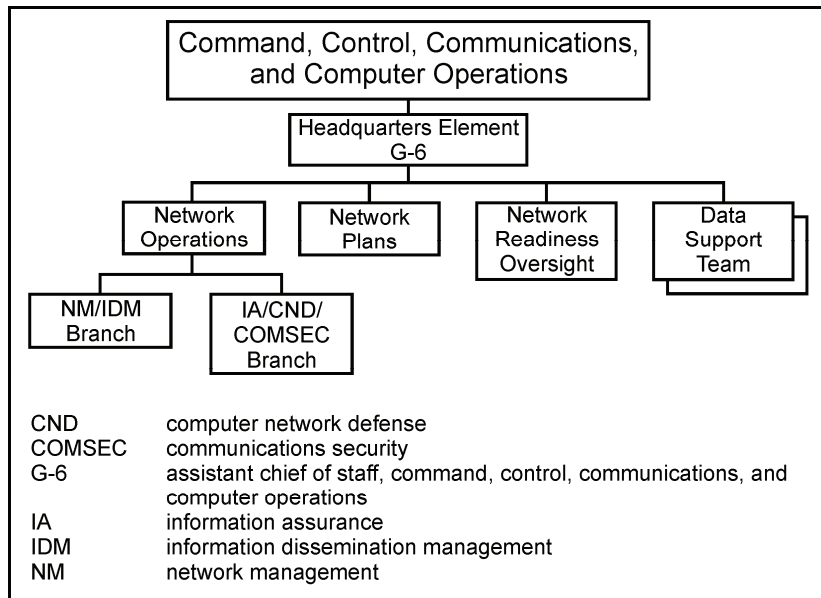

Figure 5-10. Main command post sustainment cell

**Command, Control, Communications, and Computer Operations Cell**

5-45. The division G-6 leads the C4OPS cell. This cell advises the commander and staff on all matters concerning C4OPS. The C4OPS cell conducts information management and manages network operations. Figure 5-11 shows its organization. Its specific functions include—

- Managing the COP within the division’s CPs in coordination with the knowledge management element.
- Coordinating with the G-3 to establish procedures for collecting, processing, storing, displaying, and disseminating relevant information and using information systems to display the COP.
- Incorporating and integrating network management, information dissemination management, and information assurance functions.
- Coordinating with staff sections to ensure information quality criteria are maintained.
- Controlling organic communications systems that interface with the Global Information Grid.
- Coordinating with task-organized section of the division headquarters battalion signal operations company to maintain connectivity among the main CP and the TAC CP, joint supporting assets, and higher headquarters.



**Figure 5-11. Division main command post C4OPS cell**

**Protection Cell**

5-46. The protection cell consists of a small headquarters element and the division’s chemical, biological, radiological, nuclear, and high-yield explosives; engineer; provost marshal; air and missile defense operations; personnel recovery; and operations security elements. (See figure 5-12 on page 5-16.) These staff elements coordinate closely with the division’s MEB (if one is attached) and other protection-related supporting units, as well as the other functional cells throughout the headquarters. It also develops and maintains the commander’s critical and defended asset lists and manages the division’s operations security program. Just as with the corps, the protection cell remains responsible for integrating information protection into the cells functions although the division G-6/C4OPS cell performs most of the information assurance and computer network defense functions.

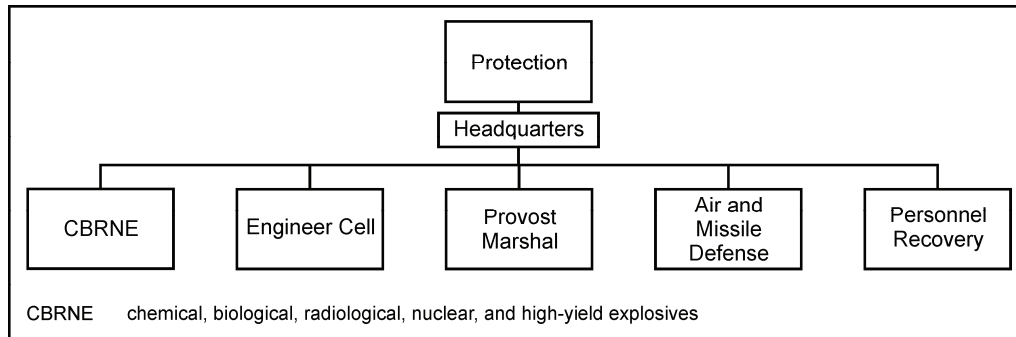

**Figure 5-12. Main command post protection cell**

### TACTICAL COMMAND POST

5-47. The division employs the TAC CP to control the execution of specific, limited scope operations, such as river crossings, passage of lines involving multiple subordinate units, or large-scale stability operations. Figure 5-13 shows its internal organization. However, the TAC CP could also control particularly complex sustaining operations such as reception, staging, onward movement, and integration involving multiple subordinate brigades. The TAC CP continuously communicates with subordinates, higher headquarters, other CPs, and supporting joint assets. When the main CP is displacing or otherwise unavailable, the TAC CP can control operations. This ability is for a limited time. However, the TAC CP requires augmentation from a main CP to C2 operations for a sustained time.

5-48. One of the two assistant division commanders controls operations from the TAC CP. The G-3 staff section oversees the operation of the TAC CP. The division commander may command the division from the deployed MCG, the TAC CP, or the main CP, as dictated by the factors of METT-TC.

5-49. The TAC CP maintains the COP for the division when the TAC CP controls the division's operations, such as when the main CP is deploying into or displacing in the JOA. In this case, the TAC CP performs duties that may include the following:

- Control units and activities conducting the decisive operation or shaping operations.
- Maintain the current operations estimate.
- Maintain and disseminate the COP throughout the division.
- Tailor the COP to meet the commander's requirements.
- Monitor division-level sustaining operations.
- Provide—
  - A forward location for issuing orders and conducting rehearsals.
  - A forward short-term planning facility when the main CP must displace.
  - The majority of the personnel and equipment to form an early entry command post (EECP).
  - Personnel for the MCG.

5-50. The TAC CP is designed and equipped to perform functions essential to the control of current operations and immediate execution decision making. The TAC CP is organized as a single integrating cell. Staff elements capable of conducting continuous operations represent all the warfighting functions. The G-7, G-9, and division personal staff officer sections provide representatives to the TAC CP as required.



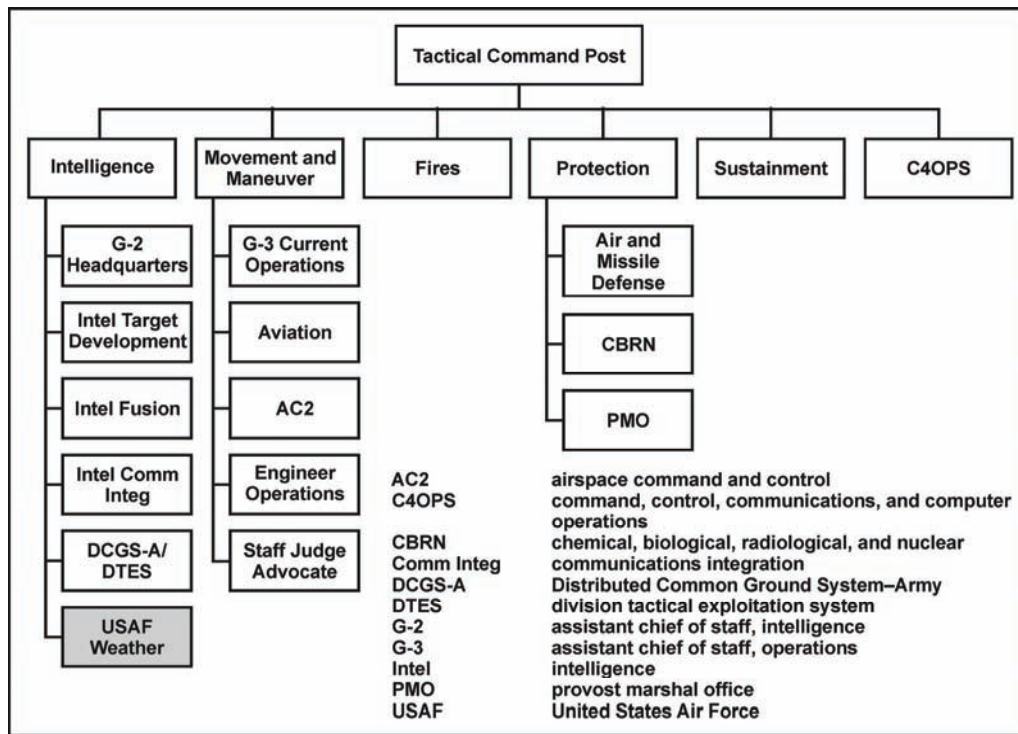

Figure 5-13. Warfighting function organization of the command post

5-51. The TAC CP is 100 percent mobile with its organic transportation assets. Factors that influence the movement of the TAC CP include the flow of operations, threat of enemy action, and desires of the commander. Eliminating the dependency on line-of-sight communications systems, with their inherent range limitations, allows the TAC CP to remain stationary longer and maintain C2 over units conducting operations over extended distances. However, the TAC CP should remain close enough to subordinate brigades for the staff to be cognizant of the operational environment in which the brigades are operating.

5-52. When notified to prepare for deployment, the TAC CP assumes a higher-readiness posture. It configures equipment and personnel into packages that fit constrained lift with the other equipment and personnel prepared to follow. A typical deployment sequence for a division might be as follows: Initially, a consolidated CP (main and tactical) at home station provides C2 of pre-deployment preparation, mission rehearsals, collaborative planning. The CP also provides virtual teaming with higher headquarters and initial phases of unit deployment. During the initial phases of deployment, the division may form an EECP from the TAC CP with additional staff augmentation from the main CP. The EECP deploys early in the deployment sequence. While the EECP is deploying, the division main CP monitors deployment of subordinate units and coordinates with the gaining headquarters. Once the EECP is fully functional within the JOA, the commander determines the best time to deploy the remainder of the main CP. The commander determines the initial locations and the sequence and timing of deployment and displacement for all CPs. After establishing a fully functional command post in the division AO, the commander deploys with elements of the command group forward.

5-53. Various TAC CP employment options exist to include the following:

- The TAC CP can act as a subordinate task force subordinate to the main CP. For example, in a widespread offensive operation, the commander may designate the TAC CP to control the operations of forces eliminating bypassed enemy forces in small cities along the line of operations while the main CP controls the decisive operation.

## **Division Headquarters Organization**

---

- The division commander may distribute control of shaping operations, sustaining operations, or both to the TAC CP while conducting complex operations. The main CP will continue to control the division's decisive operation.
- In protracted operations, the commander may combine the TAC CP and the main CP into a single co-located CP to increase the capability to control particularly complex tasks performed in the AO. (The commander may consolidate the two CPs, but that will greatly complicate kicking out a TAC CP if such an action is required later.)
- The TAC CP and main CP can employ and deploy forces simultaneously. One CP can be dedicated to controlling the deployment of forces into the AO while the other CP is in the AO controlling initial operations.

5-54. The G-3 task-organizes TAC CP elements to form working groups or other temporary matrix organizations to resolve specific problems. When conducting operations at the TAC CP, the G-3 synchronizes with planning efforts at the main CP. The current operations element at the main CP is the G-3's link to synchronize this planning. The G-3 considers the time horizons under which each CP operates and ensures that any overlap is coordinated among all command posts. Some of this overlap can include planning the air tasking order and shifting intelligence, surveillance, and reconnaissance assets.

## **UNITED STATES AIR FORCE SUPPORT TO THE DIVISION**

5-55. The USAF provides support to the division with tactical air control parties (TACPs) and air support operations center. The division ALO commands all Air Force personnel directly supporting the division and is the air component commander's direct liaison to the division commander.

### **Air Force Tactical Air Control Parties**

5-56. The TACPs are a point of contact to coordinate preplanned and immediate air requests and to assist in coordinating air support missions. Air Force personnel supporting the division main CP may include air planners, an air interdiction coordinator (co-located with the air support operations center), an intelligence officer, an information operations officer, and an air mobility liaison officer. All Air Force personnel supporting the division have a direct support relationship to the division and remain under Air Force command. Many of these personnel will come from the air support operations squadron aligned to support the division. However, some personnel may come from other Air Force organizations and may not have previously conducted training with the division.

5-57. The TACP at the main CP is the Air Force element in the division. This TAC CP is organized as an air execution cell, capable of requesting and executing type 2 or 3 control of close air support (CAS) missions. (See JP 3-09.3.) Manning is situation dependent but as a minimum will include an ALO and joint terminal attack controller. Air Force weather and intelligence support may also be incorporated into this TACP. The TACP element locates in or adjacent to the fires cell and provides airpower advice and execution support to the division. Specific air component planning and execution roles include the following:

- Execute airpower according to joint force air component commander guidance and division commander's priority, timing, and desired effects within the division AO.
- Inform the commander and staff on the capabilities and limitations of airpower.
- Accomplish training and mission rehearsal under anticipated operational conditions with the USAF and other Service counterparts.
- Exercise OPCON or tactical control of all joint terminal attack controllers operating in the division AO.
- Plan, prepare for, execute, and assess airpower—for example, CAS, air intelligence, and suppression of enemy air defenses—operating in the division AO out to the fire support coordination line.
- Prioritize, coordinate, and deconflict airpower executing missions in the division AO according to the division commander's priorities.
- Provide applicable updates to the COP for air assets tasked to support ground operations.

- Prevent fratricide through situational awareness of the COP and fire support coordinating measures.
- Ensure all subordinate TACPs and joint tactical air controllers know and understand JOA rules of engagement.
- Deconflict both air and ground assets by monitoring the COP of both friendly and enemy forces reported by intelligence and collaborative tools linked to other C2 units.
- Provide timely and efficient processing of air support requests through collaborative tools and secure communications.
- Provide fast reaction to immediate air support requests, control kill box operations, and integrate and coordinate air support missions, such as reconnaissance, electronic warfare, and airlift in the division AO.
- Forward battle damage assessment and aerial weapons effects reports to the air support operations center (ASOC).

### **United States Air Force Air Support Operations Center**

5-58. The ASOC is the air component commander's center to effectively control CAS. An ASOC locates at the division when the division is operating on a separate line of operations and is separated geographically from its higher headquarters or when the division is the JFLC or JTF. According to JP 3-09.3, the ASOC co-locates with the senior Army echelon's fires cell. Thus, depending on circumstances, it may be co-located with the theater Army operational command post, the corps main CP, or a division main CP. Three principles guide its placement:

- Do not split up the ASOC other than when it is displacing. While displacing some degradation in capability will occur.
- Locate the ASOC in a relatively secure location. Due to the firepower the ASOC can potentially bring to bear, its loss due to enemy action could seriously affect ground forces.
- Place the ASOC where its communications systems can cover the largest area. The depth at which the ASOC will control operations depends a great deal on the ability to both communicate with forces and maintain situation awareness on targets, threats, and other factors.

5-59. To control airpower, the ASOC needs to be able to communicate with the aircraft, which in most cases remains restricted by UHF (ultrahigh frequency) and VHF (very high frequency) line-of-sight considerations. This can be as far as 100 nautical miles with an aircraft at an altitude of 10,000 feet. However, commanders consider other factors such as radio power and antenna size. Also, the distance is described as an arc from the transmitter. In short, the furthest corner of the airspace that the ASOC can control meets or exceeds of the fire support coordination line to prevent creating a sanctuary from air attack for enemy forces. In mountainous terrain, these distances may be considerably less, depending on the elevation of the radio antennas in relation to the surrounding terrain. Radio relays to include ground-based radio relay systems, Joint Surveillance Target Attack Radar System aircraft, and forward air controller (airborne) and tactical air coordinator (airborne) aircraft are all means by which the ASOC may extend these distances on a limited basis.

5-60. Normally, the ASOC will co-locate with the main CP if located with the division headquarters. However, the ASOC may locate at the TAC CP. The ASOC commander recommends the best location for positioning the ASOC to the division commander based on the factors of METT-TC. Chapter 3 lists the functions provided by the ASOC.

5-61. Unlike the division TACP, ASOCs do not have a habitual relationship with the division. When used, the ASOC and division TACP merge to form one combat organization under the command of a single Airman. However, they remain equipped and manned to perform distinct functions.

### **EARLY ENTRY COMMAND POST**

5-62. The EECF is an ad hoc organization comprised of equipment and personnel from the staff of the TAC CP. The TAC CP provides the base from which to add or subtract staff officers based on mission re-

## Division Headquarters Organization

quirements to form the EECP. Commanders staff the EECP with a mix of current operations personnel and planners able to coordinate the reception of the division and plan its initial operations.

## DIVISION HEADQUARTERS BATTALION

5-63. The division headquarters battalion provides all administrative support, life support, communications, and transportation for the division's two CPs and the MCG. The division headquarters battalion is commanded by a lieutenant colonel with a complete battalion staff. The division headquarters battalion has four companies with distinct missions: headquarters and headquarters company, intelligence and sustainment headquarters company, signal operations company, and support company. The division headquarters battalion also requires a security company which is not currently resourced. When the division is assigned a band, it is assigned to the division headquarters battalion. (See figure 5-14.)

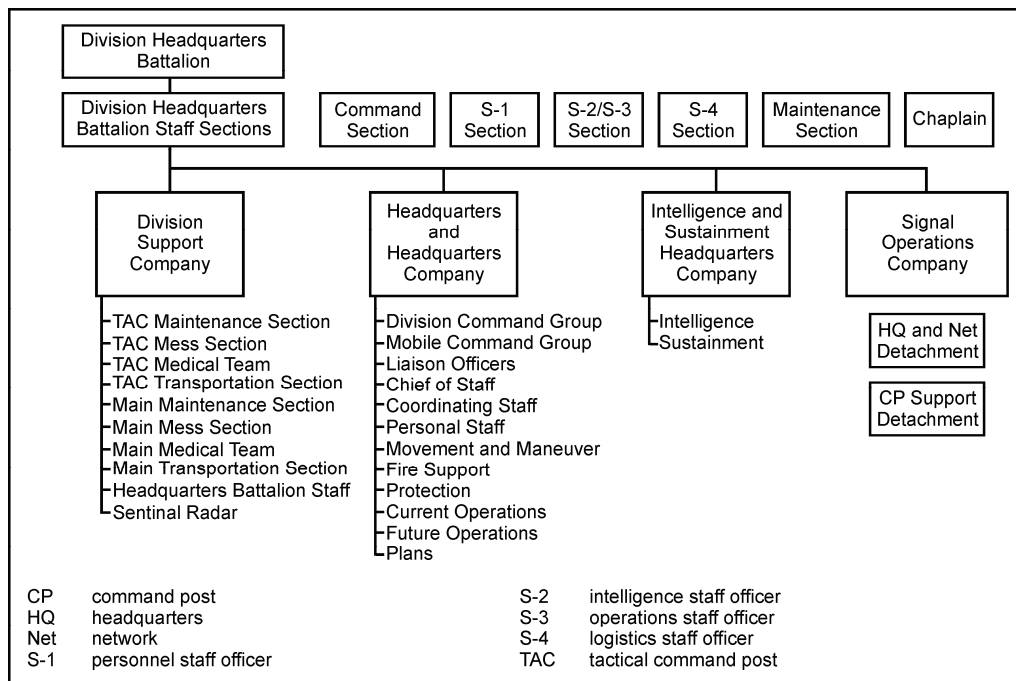

**Figure 5-14. Division headquarters battalion organization**

5-64. The division headquarters battalion commander or the designated representative assists the COS with the daily functions of the main CP and TAC CP. The division headquarters battalion commander performs the following functions:

- Provides life support, security, vehicle maintenance, field feeding, transportation, supply, and medical support to assigned and attached elements to the division headquarters.
- Provides general maintenance and upkeep of facilities.
- Provides C2 of the band and nonorganic security forces.
- Performs special duties as assigned by the COS.

5-65. When the TAC CP and main CP are dispersed, the division headquarters battalion executive officer and intelligence and sustainment headquarters company commander go with the TAC CP. They supervise the support company providing life support, security, communications, vehicle maintenance, field feeding, transportation, supply, and medical support activities to the TAC CP. The rest of the division headquarters battalion stays with the main CP to provide those same services to that organization.

5-66. Headquarters and headquarters company, intelligence and sustainment headquarters company, and signal operations company contain the staff of the division headquarters. Headquarters and headquarters company has a small company headquarters. It was assigned the following staff cells and organizations from the main CP:

- Division command group.
- Mobile command group.
- Division chief of staff and SGS.
- Liaison officers.
- All division personal staff cells and the G-7.
- Main CP movement and maneuver, fires, and protection cells.
- TAC CP movement and maneuver, fires, and protection elements.

This company also includes the current operations, future operations, and plans integrating cells.

5-67. The intelligence and sustainment headquarters company also has a small company headquarters. Its assigned personnel include the staffs of the main CP's intelligence and sustainment cells as well as the TAC CP's intelligence and sustainment elements.

5-68. The signal operations company provides communications facilities in the AO for the division headquarters. (See figure 5-15 on page 5-22.) This company provides the following:

- Communications facilities supporting the division's CPs.
- Unit-level maintenance of organic equipment and direct support maintenance of communications electronics and communications security equipment.
- Circuit switches providing service for local telephones and one large extension switch providing secure and unsecured service to subscribers.
- Two technical control centers for circuit patching, testing, and controlling terminal communications facilities.
- Four high-capacity line-of-sight radio repeaters.
- Two multiplex terminals for terminating the connecting links between the division's command posts and theater communications switching centers.
- Two Defense Message System–Army suites to provide a message system that satisfies writer-to-reader (originator-to-recipient) requirements. The Defense Message System improves functionality, security, survivability, and availability of organizational messaging services throughout the Department of Defense and its partners.
- Two antenna erection teams to assemble and disassemble the antenna towers, extending the line-of-sight multichannel over obstructions.

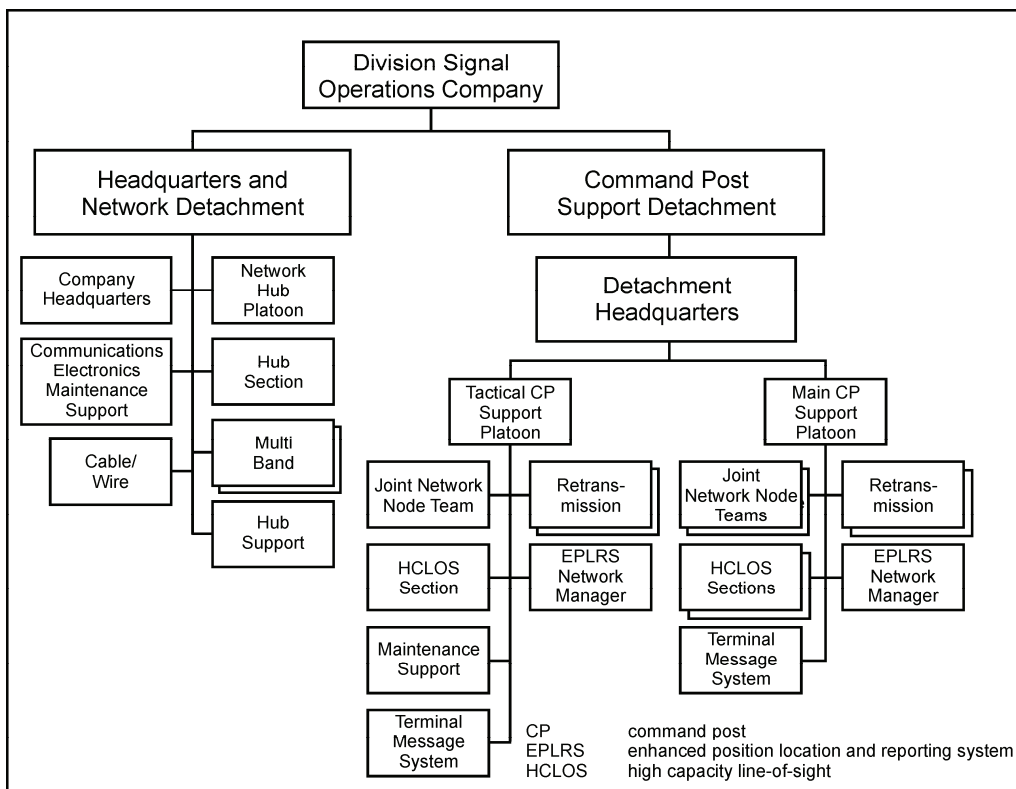

Figure 5-15. Division headquarters battalion signal operations company

5-69. The division headquarters battalion support company contains a headquarters section, maintenance platoon, medical platoon, transportation platoon, and mess section. It also contains a Sentinel radar section in its structure. Each platoon contains two sections, one to support each command post. The mess section also has two mess teams to support the two division CPs. (See figure 5-16.)

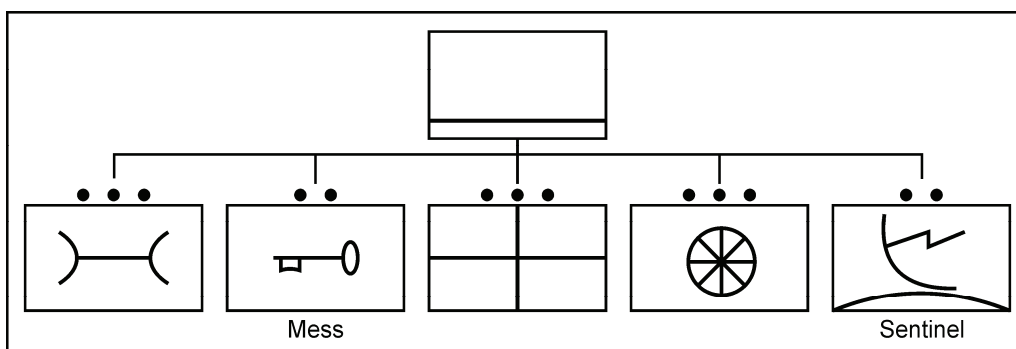

Figure 5-16. Division headquarters battalion support company

5-70. It requires roughly a maneuver company to provide security to the division’s two CPs and the MCG. This security support may be provided from a wide variety of situationally appropriate sources. These sources include—but are not limited to—tasking one of the division’s attached BCTs, tasking a company from an otherwise non-deploying BCT, and using a military police company from an attached MEB. The security force commander task-organizes the unit to perform this mission based on the factors of METT-

TC and on guidance from the division headquarters battalion commander. The security force commander stays where most security force assets perform their security missions. When a band is assigned or attached to the division headquarters battalion, the band should be included in the security plan and normally is responsible for the local security of the main CP. The security force retains responsibility for the perimeter of the base formed by the main CP and its associated life support area. This security force also conducts reconnaissance and combat patrols external to the base perimeter if allowed to do so by the host nation.

## **DIVISION HEADQUARTERS AS A JTF HEADQUARTERS**

5-71. All of the staff sections should have joint representation when the division is a JTF. The division staff must transition to a joint staff structure when so designated. However, only appropriate joint boards, centers, and cells should be established, not all possible doctrinal ones. Joint, interagency, and multinational representatives should be provided in those areas where Soldiers lack the appropriate expertise.

5-72. The JTF establishing authority provides joint personnel and other resources to the division when the division headquarters is designated as the JTF headquarters. However, the division commander, as the commander, JTF, determines what augmentation requirements and coordinated support are needed and provides that information to the establishing authority. Joint Forces Command has documented a set of standard joint manning documents for standard scenarios. The division commander has the option of retaining the functional organization of the headquarters or converting it into a standard J-staff configuration. The factors of METT-TC determine which option the commander chooses.

5-73. The commander, JTF tailors staff augmentation based on the factors of METT-TC. Usually joint and special staff sections and communications support to ensure joint communications connectivity require augmentation. A discussion of joint staff directorates, and the specific boards, centers, and cells that the JTF may need to establish on a mission basis are addressed in JP 3-33. JP 1 and JP 3-0 provide basic doctrinal guidance on JTF operations.

5-74. When the division is designated as a JTF, it requires a subordinate Army headquarters to assume the responsibilities of the ARFOR. This may be an Army brigade or a sustainment command (expeditionary). (Likewise, a division headquarters designated as a JTF headquarters should not also be designated as a JFLC headquarters without significant augmentation.)

5-75. Since the division has no organic sustainment capabilities, when a division headquarters is designated as a joint headquarters, the theater army and theater sustainment command will need to make adjustments to previous command and support relationships to reflect these new circumstances. This is because Army administrative control responsibilities, common-user logistics, and theater specific directed executive agency responsibilities will still need to be accomplished.

## **DIVISION HEADQUARTERS AS A JFLC HEADQUARTERS**

5-76. The considerations outlined in chapter 3 for transforming the theater army operational command post into a JFLC headquarters apply to transforming a division headquarters into a JFLC headquarters. This will commonly occur when a corps headquarters is designated as a JTF headquarters with numerous BCTs and other brigades assigned to the JTF.

**This page intentionally left blank.**



# Glossary

The glossary lists most terms used in this publication that have joint or Army definitions. The proponent manual for Army terms follows the definition. The proponent manual for all joint terms is JP 1-02. The glossary shows the Army definition of terms for which the joint and Army definitions are different. These terms are designated by (*Army*).

## SECTION I – ACRONYMS AND ABBREVIATIONS

<b>A2C2S</b>	Army Airborne Command and Control System
<b>AAMDC</b>	United States Army Air and Missile Defense Command
<b>ABCS</b>	Army Battle Command System
<b>ADCON</b>	administrative control
<b>AFSB</b>	Army field support brigade
<b>ALO</b>	air liaison officer
<b>AMD</b>	air and missile defense
<b>AO</b>	area of operations
<b>AOE</b>	Army of Excellence
<b>AOR</b>	area of responsibility
<b>ARFOR</b>	<i>See Section II, Terms and Definitions)</i>
<b>ARFORGEN</b>	Army force generation
<b>ARNG</b>	Army National Guard
<b>ASCC</b>	Army Service component command
<b>ASOC</b>	air support operations center
<b>ASOS</b>	Army support to other Services
<b>BCD</b>	battlefield coordination detachment
<b>BCT</b>	brigade combat team
<b>BFSB</b>	battlefield surveillance brigade
<b>C2</b>	command and control
<b>C4OPS</b>	command, control, communications, and computer operations
<b>CAB</b>	combat aviation brigade
<b>CACOM</b>	civil affairs command
<b>CAS</b>	close air support
<b>CBRN</b>	chemical, biological, radiological, and nuclear
<b>CBRNE</b>	chemical, biological, radiological, nuclear, and high-yield explosives
<b>CI</b>	counterintelligence
<b>CID</b>	criminal investigation division
<b>CIDC</b>	Criminal Investigation Division Command
<b>COMCAM</b>	combat camera

<b>CONUS</b>	continental United States
<b>COP</b>	common operational picture
<b>COS</b>	chief of staff
<b>CP</b>	command post
<b>CSCT</b>	combat support coordination team
<b>CUL</b>	common user logistics
<b>D3A</b>	decide, detect, deliver, and assess
<b>DA</b>	Department of the Army
<b>DODD</b>	Department of Defense directive
<b>DRU</b>	direct reporting unit
<b>EECP</b>	early entry command post
<b>ESC</b>	expeditionary sustainment command
<b>EUSA</b>	Eighth United States Army
<b>FA</b>	field artillery
<b>FM</b>	field manual
<b>FMI</b>	field manual-interim
<b>FORSCOM</b>	United States Army Forces Command
<b>FRAGO</b>	fragmentary order
<b>G-1</b>	assistant chief of staff, personnel
<b>G-2</b>	assistant chief of staff, intelligence
<b>G-2X</b>	assistant G-2 human intelligence
<b>G-3</b>	assistant chief of staff, operations
<b>G-4</b>	assistant chief of staff, logistics
<b>G-5</b>	assistant chief of staff, plans
<b>G-6</b>	assistant chief of staff, command, control, communications, and computer operations
<b>G-7</b>	assistant chief of staff, information operations
<b>G-8</b>	assistant chief of staff, financial management
<b>G-9</b>	assistant chief of staff, civil affairs
<b>GCC</b>	geographic combatant commander
<b>HHC</b>	headquarters and headquarters company
<b>HMMWV</b>	high mobility multipurpose wheeled vehicle
<b>IA</b>	information assurance
<b>IE</b>	information engagement
<b>IO</b>	information operations
<b>IPB</b>	intelligence preparation of the battlefield
<b>I/R</b>	internment/resettlement
<b>ISR</b>	intelligence, surveillance, and reconnaissance
<b>J-6</b>	communications system directorate of a joint staff
<b>JAOC</b>	joint air operations center
<b>JFACC</b>	joint force air component commander

---

<b>JFC</b>	joint force commander
<b>JFLC</b>	joint force land component
<b>JOA</b>	joint operations area
<b>JOPEs</b>	Joint Operation Planning and Execution System
<b>JP</b>	joint publication
<b>JTF</b>	joint task force
<b>KM</b>	knowledge management
<b>LNO</b>	liaison officer
<b>LOC</b>	line of communications
<b>MCG</b>	mobile command group
<b>MCO</b>	major combat operation
<b>MDMP</b>	military decision-making process
<b>MEB</b>	maneuver enhancement brigade
<b>MEDEVAC</b>	medical evacuation
<b>MEF</b>	Marine expeditionary force
<b>METL</b>	mission-essential task list
<b>METT-TC</b>	<i>See</i> Section II, <b>Terms and Definitions</b>
<b>MIB</b>	military intelligence brigade
<b>MLRS</b>	Multiple Launch Rocket System
<b>MOS</b>	military occupational specialty
<b>MP</b>	military police
<b>NCO</b>	noncommissioned officer
<b>NETCOM</b>	Network Enterprise Technology Command
<b>NETOPS</b>	network operations
<b>NGO</b>	nongovernmental organization
<b>OCP</b>	operational command post
<b>OGA</b>	other government agency
<b>OPCON</b>	operational control
<b>OPLAN</b>	operation plan
<b>OPORD</b>	operation order
<b>PA</b>	public affairs
<b>PIR</b>	priority intelligence requirement
<b>PSYOP</b>	psychological operations
<b>SC(T)</b>	signal command (theater)
<b>SGS</b>	secretary of the general staff
<b>SJFHQ</b>	standing joint force headquarters
<b>SOP</b>	standing operating procedure
<b>TAC CP</b>	tactical command post
<b>TACON</b>	tactical control
<b>TACP</b>	tactical air control party

<b>TAMD</b>	theater air and missile defense
<b>TCF</b>	tactical combat force
<b>TOE</b>	table of organization and equipment
<b>TSC</b>	theater sustainment command
<b>UAS</b>	unmanned aircraft system
<b>USAF</b>	United States Air Force (p. 4-9)
<b>USAR</b>	United States Army Reserve
<b>USARCENT</b>	United States Army, Central Command
<b>USAREUR</b>	United States Army, European Command
<b>USARNORTH</b>	United States Army, Northern Command
<b>USARPAC</b>	United States Army, Pacific Command
<b>USARSO</b>	United States Army, Southern Command
<b>USASOC</b>	United States Army Special Operations Command
<b>USCENTCOM</b>	United States Central Command
<b>USEUCOM</b>	United States European Command
<b>USFK</b>	United States Forces, Korea
<b>USJFCOM</b>	United States Joint Forces Command
<b>USMC</b>	United States Marine Corps
<b>USNORTHCOM</b>	United States Northern Command
<b>USPACOM</b>	United States Pacific Command
<b>USSOCOM</b>	United States Special Operations Command
<b>USSOUTHCOM</b>	United States Southern Command
<b>USSTRATCOM</b>	United States Strategic Command
<b>USTRANSCOM</b>	United States Transportation Command
<b>WMD</b>	weapons of mass destruction

## **SECTION II – TERMS AND DEFINITIONS**

### **administrative control**

(joint) Direction or exercise of authority over subordinate or other organizations in respect to administration and support, including organization of Service forces, control of resources and equipment, personnel management, unit logistics, individual and unit training, readiness, mobilization, demobilization, discipline, and other matters not included in the operational missions of the subordinate or other organizations. (JP 1)

### **area of operations**

(joint) An operational area defined by the joint force commander for land and maritime forces. Areas of operations do not typically encompass the entire operational area of the joint force commander, but should be large enough for component commanders to accomplish their missions and protect their forces. (JP 3-0)

### **area of responsibility**

(joint) The geographical area associated with a combatant command within which a combatant commander has authority to plan and conduct operations. (JP 1)

**area support**

Method of logistics, combat health support, and human resources support in which direct support (DS) combat service support relationships in effect are determined by the location of the units requiring support. Subordinate DS units provide area support to units located in or passing through their areas of responsibility. (FM 4-0)

**ARFOR**

The senior Army headquarters and all Army forces assigned or attached to a combatant command, subordinate joint force command, joint functional command, or multinational command. (FM 3-0)

**Army Service component command**

(joint) Command responsible for recommendations to the joint force commander on the allocation and employment of Army forces within a combatant command. (JP 3-31)

**base**

(joint) 1. A locality from which operations are projected or supported. 2. An area or locality containing installations which provide logistic or other support. 3. Home airfield or home carrier. (JP 1-02)

**battle**

A set of related engagements that lasts longer and involves larger forces than an engagement. (FM 3-0)

**combatant command**

(joint) A unified or specified command with a broad continuing mission under a single commander established and so designated by the President, through the Secretary of Defense and with the advice and assistance of the Chairman of the Joint Chiefs of Staff. Combatant commands typically have geographic or functional responsibilities. (JP 5-0)

**combatant command (command authority)**

(joint) Nontransferable command authority established by Title 10 ("Armed Forces"), United States Code, Section 164, exercised only by commanders of unified or specified combatant commands unless otherwise directed by the President or the Secretary of Defense. Combatant command (command authority) cannot be delegated and is the authority of a combatant commander to perform those functions of command over assigned forces involving organizing and employing commands and forces, assigning tasks, designating objectives, and giving authoritative direction over all aspects of military operations, joint training, and logistics necessary to accomplish the missions assigned to the command. Combatant command (command authority) should be exercised through the commanders of subordinate organizations. Normally this authority is exercised through subordinate joint force commanders and Service and/or functional component commanders. Combatant command (command authority) provides full authority to organize and employ commands and forces as the combatant commander considers necessary to accomplish assigned missions. Operational control is inherent in combatant command (command authority). (JP 1)

**command**

(Army) The authority that a commander in the military service lawfully exercises over subordinates by virtue of rank or assignment. Command includes the leadership, authority, responsibility, and accountability for effectively using available resources and planning the employment of, organizing, directing, coordinating, and controlling military forces to accomplish assigned missions. It includes responsibility for unit readiness, health, welfare, morale, and discipline of assigned personnel. (Upon publication of the revised FM 3-0, FM 3-0 will become the proponent for this term and definition.)

**command and control**

(Army) The exercise of authority and direction by a properly designated commander over assigned and attached forces in the accomplishment of a mission. Commanders perform command and control functions through a command and control system. (FM 6-0)

**command and control system**

(Army) The arrangement of personnel, information management, procedures, and equipment and facilities essential for the commander to conduct operations. (FM 6-0)

### **commander's intent**

(Army) A clear, concise statement of what the force must do and the conditions the force must establish with respect to the enemy, terrain, and civil considerations that represent the desired end state. (Upon publication of the revised FM 3-0, FM 3-0 will become the proponent for this term and definition.)

### **commander's visualization**

The mental process of developing situational understanding, determining a desired end state, and envisioning the broad sequence of events by which the force will achieve that end state. (Upon publication of the revised FM 3-0, FM 3-0 will become the proponent for this term and definition.)

### **common operational picture**

(Army) A single display of relevant information within a commander's area of interest tailored to the user's requirements and based on common data and information shared by more than one command. (Upon publication of the revised FM 3-0, FM 3-0 will become the proponent for this term and definition.)

### **component**

(joint) One of the subordinate organizations that constitute a joint force. Normally a joint force is organized with a combination of Service and functional components. (JP 1)

### **decisive operation**

The operation that directly accomplishes the mission assigned by the higher headquarters. Decisive operations conclusively determine the outcome of major operations, battles, and engagements. The decisive operation is the focal point around which commanders design an entire operation or phase. (Upon publication of the revised FM 3-0, FM 3-0 will become the proponent for this term and definition.)

### **decisive point**

(joint) A geographic place, specific key event, critical factor, or function that, when acted upon, allows commanders to gain a marked advantage over an adversary or contributes materially to achieving success. (JP 3-0)

### **engagement**

(joint) A tactical conflict, usually between opposing lower echelon maneuver forces. (JP 1-02)

### **footprint**

(joint) The amount of personnel, spares, resources, and capabilities present and occupying space at a deployed location. (JP 1-02)

### **force tailoring**

The process of determining the right mix and sequence of units for a mission. (FM 3-0)

### **functional component command**

(joint) A command normally, but not necessarily, composed of forces of two or more Military Departments which may be established across the range of military operations to perform particular operational missions that may be of short duration or may extend over a period of time. (JP 1)

### **Global Information Grid**

(joint) The globally interconnected end-to-end set of information capabilities, associated processes and personnel for collecting, processing, storing, disseminating, and managing information on demand to warfighters, policy makers, and support personnel. The Global Information Grid includes all owned and leased communications and computing systems and services, software (including applications), data, security services, other associated services, and National Security Systems. (JP 6-0)

### **information engagement**

The integrated employment of public affairs, psychological operations, combat camera, and other means necessary to inform or influence enemy, adversary, neutral, and friendly audiences. It includes

the interaction of commanders and Soldiers with these audiences. (Upon publication of the revised FM 3-0, FM 3-0 will become the proponent for this term and definition.)

**information environment**

(joint) The aggregate of individuals, organizations or systems that collect, process, or disseminate or act on information. (JP 3-13)

**information system**

(Army) The equipment and facilities that collect, process, store, display, and disseminate information. This includes computers—hardware and software—and communications, as well as policies and procedures for their use. (FM 3-0)

**intelligence, surveillance, and reconnaissance**

(joint) An activity that synchronizes the planning and operations of sensors, assets, and processing, exploitation, and dissemination systems in direct support of current and future operations. This is an integrated intelligence and operations function. (JP 2-01)

**joint operations area**

(joint) An area of land, sea, and airspace defined by a geographic combatant commander or subordinate unified commander in which a joint force commander (normally a joint task force commander) conducts military operations to accomplish a specific mission. (JP 3-0)

**joint security area**

(joint) A specific surface area, designated by the joint force commander to facilitate protection of joint bases that support joint operations. (JP 3-10)

**knowledge management**

The art of creating, organizing, applying, and transferring knowledge to facilitate situational understanding and decision making. (Upon publication of the revised FM 3-0, FM 3-0 will become the proponent for this term and definition.)

**line of operations**

(Army) A line that defines the directional orientation of a force in time and space in relation to the enemy and links the force with its base of operations and objectives. (Upon publication of the revised FM 3-0, FM 3-0 will become the proponent for this term and definition.)

**major operation**

(joint) A series of tactical actions (battles, engagements, strikes) conducted by combat forces of a single or several Services, coordinated in time and place, to achieve strategic or operational objectives in an operational area. These actions are conducted simultaneously or sequentially in accordance with a common plan and are controlled by a single commander. For noncombat operations, a reference to the relative size and scope of a military operation. (JP 3-0)

**METT-TC**

A memory aid used in two contexts: (1) In the context of information management, the major subject categories into which relevant information is grouped for military operations: mission, enemy, terrain and weather, troops and support available, time available, civil considerations. (2) In the context of tactics, the major factors considered during mission analysis. (FM 6-0)

**mission**

(DOD) 1. The task, together with the purpose, that clearly indicates the action to be taken and the reason therefor. (JP 1-02)

**mission command**

The conduct of military operations through decentralized execution based upon mission orders for effective mission accomplishment. Successful mission command results from subordinate leaders at all echelons exercising disciplined initiative within the commander's intent to accomplish missions. It requires an environment of trust and mutual understanding. (FM 6-0)

### **mission orders**

A technique for developing orders that emphasizes to subordinates the results to be obtained and not how to achieve them. It provides maximum freedom of action in determining how best to accomplish the mission. (Upon publication of the revised FM 3-0, FM 3-0 will become the proponent for this term and definition.)

### **network operations**

(Army) The collaborative, integrated management of networks, information systems, and resources that provide a common operational picture. (Upon publication, FM 6-02.7 will be the proponent for this definition.)

### **operational control**

(joint) Command authority that may be exercised by commanders at any echelon at or below the level of combatant command. Operational control is inherent in combatant command (command authority) and may be delegated within the command. When forces are transferred between combatant commands, the command relationship the gaining commander will exercise (and the losing commander will relinquish) over these forces must be specified by the Secretary of Defense. Operational control is the authority to perform those functions of command over subordinate forces involving organizing and employing commands and forces, assigning tasks, designating objectives, and giving authoritative direction necessary to accomplish the mission. Operational control includes authoritative direction over all aspects of military operations and joint training necessary to accomplish the missions assigned to the command. Operational control should be exercised through the commanders of subordinate organizations. Normally this authority is exercised through subordinate joint force commanders and Service and/or functional component commanders. Operational control normally provides full authority to organize commands and forces and to employ those forces as the commander in operational control considers necessary to accomplish assigned missions; it does not, in and of itself, include authoritative direction for logistics or matters of administration, discipline, internal organization, or unit training. (JP 1)

### **operational reach**

(joint) The distance and duration across which a unit can successfully employ military capabilities. (JP 3-0)

### **reachback**

(joint) The process of obtaining products, services, and applications, or forces, or equipment, or material from organizations that are not forward deployed. (JP 3-30)

### **shaping operation**

An operation at any echelon that creates and preserves conditions for the success of decisive operations. (FM 3-0)

### **situational understanding**

The product of applying analysis and judgment to relevant information to determine the relationship between the factors of METT-TC to facilitate decision making. (Upon publication of the revised FM 3-0, FM 3-0 will become the proponent for this term and definition.)

### **strike**

(joint) An attack to damage or destroy and objective or a capability. (JP 3-0)

### **subordinate unified command**

(joint) A command established by the commanders of unified commands, when so authorized through the Chairman of the Joint Chiefs of Staff, to conduct operations on a continuing basis in accordance with the criteria set forth for unified commands. A subordinate unified command may be established on an area or functional basis. Commanders of subordinate unified commands have functions and responsibilities similar to those of commanders of unified commands and exercise operation control of assigned commands and forces within the assigned operational area. (JP 1)



**\*support area**

A specific surface area designated by the echelon commander to facilitate the positioning, employment, and protection of resources required to sustain, enable, and control tactical operations.

**tactical combat force**

(joint) A combat unit, with appropriate combat support and combat service support assets, that is assigned the mission of defeating Level III threats. (JP 3-10)

**task organization**

(Army) A temporary grouping of forces designed to accomplish a particular mission. (FM 3-0)

**task organizing**

(Army) The process of allocating available assets to subordinate commanders and establishing their command and support relationships. (FM 3-0)

**tempo**

The rate of military action. (FM 3-0)

**unified action**

(joint) The synchronization, coordination, and/or integration of the activities of governmental and nongovernmental entities with military operations to achieve unity of effort. (JP 1)

**unified command**

(joint) A command with a broad continuing mission under a single commander and composed of significant assigned components of two or more Military Departments, that is established and so designated by the President through the Secretary of Defense with the advice and assistance of the Chairman of the Joint Chiefs of Staff. (JP 1)

**This page intentionally left blank.**

## References

Military publications are listed by title. When a field manual has been published under a new number for the first time, the old number is provided in parenthesis after the new number.

### REQUIRED PUBLICATIONS

These documents must be available to intended users of this publication.

FM 1-02. *Operational Terms and Graphics {MCRP 5-12A}*. 21 September 2004.

FM 3-0. *Operations*. 14 June 2001.

FM 3-90. *Tactics*. 4 July 2001.

JP 1-02. *Department of Defense Dictionary of Military and Associated Terms*. 12 April 2001. (JP 1-02 is updated periodically. This publication was prepared using JP 1-02 amended through 13 June 2007.)

### RELATED PUBLICATIONS

These sources contain relevant supplemental information.

#### JOINT AND DEPARTMENT OF DEFENSE PUBLICATIONS

DODD 5100.73. *Major Department of Defense Headquarters Activities*. 13 May 1999.

JP 1. *Doctrine for the Armed Forces of the United States*. 14 May 2007.

JP 3-0. *Joint Operations*. 17 September 2006.

JP 3-08. *Interagency, Intergovernmental Organization, and Nongovernmental Organization Coordination During Joint Operations*. 17 March 2006.

JP 3-09.3. *Joint Tactics, Techniques, and Procedures for Close Air Support (CAS)*. 03 September 2003.

JP 3-10. *Joint Security Operations in Theater*. 01 August 2006.

JP 3-16. *Multinational Operations*. 07 March 2007.

JP 3-31. *Command and Control for Joint Land Operations*. 23 March 2004.

JP 3-33. *Joint Task Force Headquarters*. 16 February 2007.

JP 5-0. *Joint Operation Planning*. 26 December 2006.

#### SERVICE PUBLICATIONS

*Army Campaign Plan*. 15 December 2006.

FM 1. *The Army*. 14 June 2005.

FM 3-04.111 (FM 1-111). *Aviation Brigades*. 7 December 2007.

FM 3-05.40 (FM 41-10). *Civil Affairs Operations*. 29 September 2006.

FM 3-07 (FM 100-20). *Stability Operations and Support Operations*. 20 February 2003.

FM 3-11 (FM 3-100). *Multiservice Tactics, Techniques, and Procedures for Nuclear, Biological, and Chemical Defense Operations*. 10 March 2003.

FM 3-13 (FM 100-6). *Information Operations: Doctrine, Tactics, Techniques, and Procedures*. 28 November 2003.

FM 3-14. *Space Support to Army Operations*. 18 May 2005.

## References

---

- FM 3-19.1 (FM 19-1). *Military Police Operations*. 22 March 2001.
- FM 3-19.40. *Internment/Resettlement Operations*. 04 September 2007.
- FM 3-31. *Joint Force Land Component Commander Handbook (JFLCC) MCWP 3-40.7*. 13 December 2001.
- FM 3-90.6 (FM 3-21.31, FM 3-90.3, and FM 7-30). *The Brigade Combat Team*. 04 August 2006.
- FM 5-0 (FM 101-5-1). *Army Planning and Orders Production*. 20 January 2005.
- FM 6-0. *Mission Command: Command and Control of Army Forces*. 11 August 2003
- FM 46-1. *Public Affairs Operations*. 30 May 1997. (Will be republished as FM 3-61.)
- FM 100-8. *The Army in Multinational Operations*. 24 November 1997. (Will be republished as FM 3-16.)
- FM 100-13. *Battlefield Coordination Detachment (BCD)*. 05 September 1996.
- FMI 4-93.41 (FM 63-11). *Army Field Support Brigade Tactics, Techniques, and Procedures*. 22 February 2007.
- FMI 5-0.1. *The Operations Process*. 31 March 2006.

## OTHER PUBLICATIONS

- Title 10. United States Code. Armed Forces.

## PRESCRIBED FORMS

- DA Form 2028, *Recommended Changes to Publications and Blank Forms*.

## REFERENCED forms

- None

# Index

## A

air component, 5-14–5-15  
air support operations center. *See* ASOC.  
airfield operations, 3-80  
air and missile defense, brigades, 3-66–3-67  
    command, 3-64–3-67  
    missions, 3-65  
AOE, 1-30, 5-1, 5-42  
    command post and, 1-15  
    constructs of, 1-10  
    designs of, 1-12  
ARFOR, 3-90, 3-94, 4-4, 4-7  
ARFOR commander, 3-2, 3-15, 3-84, 3-88, 3-98  
    BCD and, 3-61–3-62  
    support to, 3-101  
    tasks, 1-34, 3-86–3-87  
ARFORGEN, 1-49  
    elements of, 2-8  
    process, 3-37  
Army Airborne Command and Control System, 5-14  
Army Battle Command System, 5-16  
    knowledge management and, 4-37  
    MCG and, 4-12  
Army Campaign Plan, 1-9, 3-34  
Army command, 1-13, 2-2, 2-19  
Army field support brigade, 3-26, 3-69–3-70  
Army force generation. *See* ARFORGEN.  
Army forces, 1-1–1-72  
    ADCON, 2-25  
    affected by, 2-16  
    assignment of, 2-1, 2-22  
    control of, 3-2  
    integrating, 1-18, 3-3  
    modular, 1-72  
    organizing, 2-1–2-7, 2-26  
    support from, 1-4–1-8, 2-4  
    support to, 3-6, 3-9, 3-22, 3-29, 4-6  
Army of Excellence. *See* AOE.  
Army Service component command. *See* ASCC.  
Army space support teams, 3-107

ASCC, 1-13, 1-15, 2-1, 2-19, 3-1, 3-55–3-57, 5-58–5-61  
ASOC, functions of, 3-55  
    location, 3-56, 5-58  
augmentation, 1-23, 3-4, 3-125, 4-5, 4-58, 4-59, 5-72–5-73  
    corps headquarters, 1-21  
    MIB and, 3-47  
available force pool, 2-12–2-13  
aviation brigade, support from, 3-77, 3-78  
    theater assault, 3-79

## B

battlefield coordination detachment, 3-58–3-63  
battlefield surveillance brigade. *See* BFSB.  
BCT, 1-26, 1-28–1-32  
    MEB, 1-58  
    division and, 5-4  
    strategic planning and, 2-20  
    types of, 1-28  
BFSB, 1-34–1-41  
    limitations of, 1-38  
    organization of, 1-35  
    staff, 1-40  
    support from, 1-39  
    using resources, 1-38  
brigade combat team. *See* BCT.  
brigades, 2-27. *See also* individual brigades.  
    supporting, 1-25, 1-32–1-33  
    theater level, 3-68–3-115

## C

C2, 1-12, 3-1, 3-15, 3-16, 3-23, 3-71, 5-3  
    capabilities, 4-1, 4-6  
    corps, 1-20  
    divisions, 5-4  
    elements, 3-110, 5-11  
    establishing, 3-27  
    main CP and, 5-20  
    relationship, 3-85  
    subordinates, 3-38  
    sustainment and, 1-62, 1-66  
    TSC and, 3-25–3-27  
C4OPS, 3-32, 3-38  
    cell, 4-42–4-43, 5-45  
CAB, 1-44–1-52, 2-27, 3-81, 5-4, 5-6  
    missions, 1-45

    support from, 1-44  
campaign plan, 3-29, 3-30, 4-6  
CBRN, assets, 3-88  
    defense, 3-86  
    force organization, 3-84  
CBRNE, headquarters, 3-71–3-73  
chain of command, 2-2, 2-22, 3-102  
challenges, strategic, 1-2  
chemical, biological, radiological, and nuclear. *See* CBRN.  
chemical, biological, radiological, nuclear, and high-yield explosives. *See* CBRNE.  
civil affairs, brigade, 3-48–3-52  
    command, 3-48–3-52  
    operations center, 3-48, 3-49  
    units, 1-17  
civil authorities, support to, 2-8, 2-10  
Cold War, 1-4, 1-5, 1-7, 1-11  
combat aviation brigade. *See* CAB.  
combat camera, 3-42  
maneuver enhancement brigade. *See* MEB.  
combat support coordination teams, 3-114  
combatant command, 2-2, 3-2  
combatant commanders, 2-1, 2-3, 2-8, 3-125  
command, relationships, 2-15, 3-21  
    theater level, 3-68–3-115  
command and control. *See* C2.  
command and control warfighting function, table 1-5  
command, control, communications, and computer operations. *See* C4OPS.  
commander(s). *See also* individual commanders.  
    ARFOR, 3-2, 3-87–3-88  
    MEB, 1-55  
    headquarters battalion, 5-64  
    location, 4-11  
    presence, 5-9, 5-10  
    support to, 3-40, 3-101, 4-19  
    tasks, 3-41, 4-10, 4-14, 4-18, 4-58, 5-8, 5-10, 5-12, 5-22

theater army, 1-15, 1-18, 2-5, 2-22, 2-24, 3-2, 3-3, 3-5, 3-8, 3-15, 3-17–3-18

commander's intent, 1-31, 3-29, 4-33, 4-40, 5-43

communications, 1-35, 3-30, 3-57, 5-15, 5-59

communications security, theater, 3-33

concept of operations, 1-31, 1-48

concepts, modular theater army, 3-11

coordinating staff, 3-9, 5-30  
elements, 4-21, 5-24  
main CP, 4-30–4-34

coordination, 3-61, 3-113

corps, commander, 1-32  
CP, 4-9–4-51  
higher echelons and, 1-20–1-22

corps headquarters, augmentation to, 4-20  
JFLC headquarters, 4-62  
JTF headquarters, 4-57–4-61  
modular, 4-8  
organization, 4-1–4-62  
roles of, 4-1–4-7  
support to, 3-3

CP, corps, 4-9–4-51  
division, 5-10–5-62  
location, 5-8  
security, 3-116  
task-organizing, 4-10, 4-56  
theater army, 3-7

criminal investigation division, 3-101–3-104

current operations cell, 4-21–4-22, 4-47, 5-32–5-33

current operations integrating center, 3-14

**D–E**

defense, CBRN, 3-84, 3-86

direct reporting unit, 1-13, 1-14, 2-19

direct support, 1-48

distribution, TSC and, 3-29

division, commander, 1-32  
example, figure 1-6  
higher echelons and, 1-23–1-26  
modular, 1-23, 5-1–5-9

division headquarters, deployed, 5-11  
JFLC headquarters and, 5-76

JTF headquarters and, 5-71–5-75  
organization, 1-24, 1-26, 5-1–5-76  
support to, 3-3

doctrine, 1-3, 3-123, 3-127

early entry command post. See EECP.

EECP, 3-65, 4-51, 5-19  
capabilities, 3-17  
division headquarters and, 5-62  
OCP and, 3-16–3-19

engineer, support from, 3-75

expeditionary force packages, 2-11–2-12, 2-14, 5-3

expeditionary signal battalion, 3-40

**F**

fires brigade, 1-42–1-43

fires cell, 4-40, 5-43

fires warfighting function, table 1-3

force packages, 2-5, 2-6

force pool, 3-24, 3-35  
types, 2-8  
understanding, 2-8–2-14

force tailoring, 2-5, 2-18, 2-24–2-25, 3-8, 3-96

frequency management, theater, 3-33

full spectrum operations, 1-3, 1-12, 3-39, 3-101, 5-3

functional brigades, 1-63, 1-70–1-71, 2-9, 5-7

functional combatant commander, 2-4, 3-1, 3-2

functional component commands, 3-117

future operations, 3-70, 4-15, 4-29, 4-36, 5-12, 5-35, 5-41

future operations cell, 4-23, 5-34

**G–H–I**

GCC, 1-13, 1-20, 2-4, 2-24, 3-2, 3-6, 3-48, 3-118, 3-121, 3-125  
AOR, 1-15, 2-21, 3-10, 3-12  
corps headquarters and, 4-1  
requirements of, 2-5  
support to, 3-1, 3-9, 3-21, 3-32  
tailoring, 3-8

generating force, 2-8

geographic combatant commander. See GCC.

Global Information Grid, 3-38, 3-39

ground component, 5-13, 5-15

headquarters battalion, 1-15  
corps, 4-56  
division, 5-63–5-70  
organization, 5-63  
theater army, 3-20

headquarters element, corps, 4-19–4-20  
division, 5-25–5-28

higher echelons, 1-12–1-26

I/R, 3-97–3-100

information engagement, defined, 4-31  
functions, 4-33  
working group, 4-33–4-34

information operations, 3-105

information systems, 1-30, 3-12, 4-40, 5-8, 5-17

integrate/integrated/integration, 3-29, 3-62, 3-64–3-65, 4-17, 4-21, 4-33, 4-36, 4-47  
Army forces, 1-18, 3-3  
cells, 5-23, 5-31–5-46  
center, 3-14  
joint, 4-54  
multinational, 4-55  
operations, 1-49

intelligence, 3-61, 4-34, 5-15, 5-57  
capabilities, 3-46  
collection of, 1-34–1-41  
teams, 1-39

intelligence cell, 4-39, 5-42

intelligence warfighting function, table 1-2

intelligence, surveillance, and reconnaissance. See ISR.

internment/resettlement. See I/R.

ISR, BFSB and, 1-34  
plan, 1-37

**J–K–L**

JFLC, 1-19, 1-71, 4-2, 4-5, 4-7  
commander, 3-49  
OCP, 3-117–3-123

JFLC headquarters, 1-20, 3-5, 5-5  
corps headquarters, 4-62  
division headquarters and, 5-76

JOA, 1-15, 1-21, 3-5, 3-22, 3-88  
aviation brigade and, 3-77  
EECP and, 3-15–3-16  
main CP and, 5-19  
MIB and, 3-45

multiple, 3-121  
 OCP and, 3-121–3-122  
 organization, 3-86  
 support to, 4-6  
 TSC and, 3-25, 3-27

joint air operations center, 3-59, 3-61, 3-62

joint commands, support to, 2-22

joint force land component. *See* JFLC.

joint forces, 1-1–1-72, 3-71, 3-118  
 Army contributions to, 1-4–1-8  
 headquarters, 1-21  
 protection of, 1-6  
 support to, 3-3, 3-6

joint manning, 4-5–4-6  
 document, 1-21, 3-125, 4-58, 5-72

joint operations area. *See* JOA.

Joint Strategic Capabilities Plan, 3-64

joint task force. *See* JTF.

JTF, 4-54  
 OCP and, 3-124–3-127  
 support to, 1-34, 3-106

JTF headquarters, 1-20, 3-4, 3-118, 3-125–3-127, 4-2, 4-3  
 corps headquarters, 4-57–4-61  
 division headquarters and, 5-71–5-75

knowledge management, 4-37

land power, 3-1

LandWarNet, 3-33, 3-38–3-39

liaison, 3-49, 3-58, 4-19, 4-52, 4-54, 4-55, 5-25, 5-27, 5-55  
 detachments, 3-110–3-114

line of communications, support to, 3-91

## M

main command post. *See* main CP.

main CP, 1-15  
 ASOC and, 5-60  
 cells, 4-35–4-46, 5-24  
 coordinating staff, 4-30–4-34  
 corps, 4-8, 4-15–4-46  
 division headquarters and, 5-17–5-22  
 functions of, 3-10, 3-12, 4-16, 5-17  
 headquarters battalion and, 5-65  
 location, 3-13, 4-18, 5-21–5-22, 5-60  
 organization, 4-17, 5-18, 5-23–5-46

staff, 4-27–4-29, 5-39  
 support from, 3-9  
 TACP and, 5-57  
 theater army, 3-9–3-14

major combat operations. *See* MCO.

MCG, 4-11–4-14  
 air component, 5-14  
 division, 5-12–5-16  
 ground component, 5-13

MCO, 1-15, 1-25, 3-32  
 chemical support, 3-83  
 corps headquarters and, 1-22  
 division, 5-5  
 engineer command and, 3-74  
 joint forces and, 3-118  
 OCP and, 3-5  
 theater army and, 1-18

MEB, 1-53–1-63  
 missions of, 1-54

medical deployment support command, 3-53–3-54

military intelligence brigade, 3-43–3-47

military police. *See* MP.

mission orders, CAB, 1-46  
 division and, 5-7

mission staging, 1-69, 5-4

missions, attack, 1-48–1-49  
 CAB, 1-45, 1-49  
 screening, 1-50

mobile command group. *See* MCG.

mobility, providing, 1-53

modular Army, 1-72, 2-8, 2-17–2-18, 2-24  
 transformation to, 1-9–1-69

modular division, 5-1–5-9

modular forces, 2-3, 2-12, 2-15  
 design, 3-31  
 organizing, 2-16–2-29

modular force organization, 2-1–2-29

modular organization, brigade-sized, 1-27–1-69  
 transformation to, 1-9

modular theater army, concepts of, 3-11

movement and maneuver cell, 4-36–4-38, 5-40–5-41

movement and maneuver war-fighting function, table 1-1

MP, brigade, 3-90–3-100  
 command, 3-89–3-104  
 CID and, 3-104

multinational, integration, 4-55

## N–O

National Military Strategy, 2-4

national strategy, support to, 2-4

networks operations, 3-33, 3-39, 4-42, 5-45

OCP, 1-15, 3-7  
 JFLC, 3-117–3-123  
 JTF and, 3-124–3-127  
 organization of, 3-15  
 theater army, 3-4, 3-15–3-19

operating force, 2-8

operational base, 3-36–3-37

operational command post. *See* OCP.

operations, concepts for, 1-2–1-3

operations research and systems analysis, 4-28

organization(s), brigades, 1-33  
 corps headquarters, 4-1–4-62  
 division headquarters, 5-1–5-76  
 MIB, 3-45  
 modular force, 2-16–2-29  
 strategic, 2-7  
 theater army, 3-1–3-127  
 types of, 1-13

## P–Q–R

personal staff, 4-27–4-29, 4-35, 5-29

planning, 4-25–4-26, 5-38  
 personal staff and, 4-29

plans cell, 4-24–4-26, 5-35–5-38

political-military element, 4-38

protection, 1-59, 3-65, 3-82, 3-105  
 provide, 1-53, 1-55

protection cell, 4-44–4-46, 5-46

protection warfighting function, table 1-6

psychological operations, 3-106

public affairs, 3-108–3-109, 4-32

ready force pool, 2-11

rear area operations centers, 3-115

reconnaissance, 1-34, 1-35, 1-38  
 BCT and, 1-29

Red Team, 4-29

relationships, 1-26, 3-85, 5-1  
 changing, 2-26, 5-75  
 command, 1-22, 2-15, 2-24, 3-21  
 establishing, 1-64, 2-6  
 support to, 2-28

replenishment, 1-69  
 reset/train force pool, 2-10

**S**

security, 1-51, 5-15  
   ASOC, 3-57  
   BCT, 5-7  
   communications, 3-33  
   cooperation plans, 1-18, 3-3, 3-44–3-45  
   CP, 3-116  
   MEB, 1-58  
   headquarters battalion, 4-56, 5-70  
   joint, 3-91, 3-114, 3-115  
   MCG and, 4-14  
   MPs and, 3-90  
   providing, 3-95  
 signal brigade, operational base, 3-38  
 signal command (theater), 3-31–3-42  
 signal forces, 3-31, 3-36  
 space support, 3-107  
 staff, 1-40, 1-65, 3-12, 5-39  
 strategic organization, 2-7, 2-17–2-23  
   force tailoring and, 2-24  
 subordinate commands, theater army, 3-21–3-115  
 support, types of brigades, 1-25  
 support area, defined, 1-56  
 support brigades, 1-32–1-33  
   capabilities of, 1-33  
   modular division, 5-1  
   strategic planning and, 2-20  
   types of, figure 1-8  
 supporting commands, 3-22  
 sustainment, changes to, 1-7–1-8  
   support to, 3-77  
 sustainment brigade, 1-64–1-69  
 sustainment cell, 4-41, 5-44  
 sustainment command (expeditionary), 3-25, 3-27–3-28  
 sustainment warfighting function, 1-68, table 1-4, 3-23  
 synchronization, 3-60

**T U–V**

TAC CP, 4-47–4-50, 5-65  
   corps headquarters, 4-8  
   division headquarters, 5-47–5-54  
 tactical air control party, 5-56–5-57

tactical command post. See TAC CP  
 tactical installation and networking company, 3-41  
 tactical signal brigade, 3-35  
 targets, identifying, 1-41  
 task organization/task-organizing, 2-6, 2-7, 2-26–2-29  
   considerations of, 2-27  
   example of, figure 2-6  
 theater army, ADCON of, 3-21  
   BCD and, 3-62  
   functions of, 3-2  
   headquarters, 1-15–1-19, 3-7–3-20  
   main CP and, figure 3-2  
   organization, 1-16–1-17, 3-1–3-127  
   role of, 3-1–3-6  
   subordinate commands of, 3-21–3-115  
   support from, 3-1, 3-6  
 theater army commander(s), 3-58, 3-93, 3-122  
   designation of, 3-49  
   links to, 3-18  
   MIB and, 3-46  
   relationship, 3-85  
   representatives of, 3-111  
   support from, 1-17  
   support to, 1-32, 3-49  
 theater aviation support, 3-76–3-81  
 theater chemical support, 3-82–3-88  
 theater distribution, 1-67  
 theater engineer command, 3-74–3-75  
 theater MP command, 3-89–3-104  
 theater network operations and security center, 3-39  
 theater opening, 1-66  
 theater sustainment command. See TSC.  
 threats, 1-58–1-59  
 time horizons, 4-25, 5-36  
 training, 2-4, 2-10–2-11, 3-1, 3-84, 3-119, 5-3  
   chemical, 3-82  
   MEB, 1-58  
 transformation, signal forces, 3-31  
   structure, 1-13  
   sustainment, 1-8  
   to modular Army, 1-9–1-69  
 TSC, 1-17, 1-25–1-26, 1-64, 3-22, 3-23–3-30

example of, figure 3-6  
 mission of, 3-25  
 organization of, 3-24  
 TSC commander, 3-26  
 U.S. Army Air and Missile Defense Command, 3-64–3-65  
 unit readiness, 2-8  
 United States Air Force, 4-52–4-53, 5-55–5-61  
 United States Marine Corps, 4-54  
 unmanned aircraft system, 1-35, 1-39, 3-80

**W–X–Y–Z**

warfighting functional cells, 4-30, 5-39–5-46  
 warfighting functions, 1-5, 1-30, tables 1-1–1-6, 4-17, 4-46, 5-18, 5-31, 5-43  
   mission orders and, 5-7  
 weapons of mass destruction, 3-71–3-72



**FMI 3-0.1**  
**28 January 2008**

By Order of the Secretary of the Army:

**GEORGE W. CASEY, JR.**  
*General, United States Army*  
*Chief of Staff*

Official:



**JOYCE E. MORROW**  
*Administrative Assistant to the*  
*Secretary of the Army*  
0800802

**DISTRIBUTION:**

*Active Army, U.S. Army Reserve, and Army National Guard; Not to be distributed; electronic media only.*

